

seemanntechnologies

Produktkatalog / Product catalogue /
Catálogo de productos

Zubehör für die HF-Chirurgie















Accessories for Electro-Surgery

Accesorios para Electro Cirugía

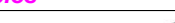

seemanntechnologies







Seemann Technologies GmbH, Panoramastrasse 20, D - 78583 Böttingen
Tel. +49 (0) 7429 9300 388 Fax +49 (0) 7429 9300 390
E-Mail: info@seemann-technologies.com www.seemann-technologies.com

| | | |
|--|--|---------|
| 4 mm Elektroden isoliert <i>4 mm electrodes insulated</i> <i>Electrodos aislados de 4 mm</i> |  | 3 - 14 |
| 4 mm Stahlelektroden <i>4 mm steel electrodes</i> <i>Electrodos de acero de 4 mm</i> |  | 15 |
| 2,4 mm Elektroden, international, isoliert <i>2,4 mm electrodes, international, insulated</i> <i>Electrodos aislados internacionales de 2,4 mm</i> |  | 16 - 22 |
| 1,6 mm Elektroden, dental <i>1,6 mm electrodes, dental</i> <i>Electrodos dentales de 1,6 mm</i> |  | 23 |
| Biegsame Elektroden für die plastische Chirurgie <i>Flexible electrodes for the plastic surgery</i> <i>Electrodos flexibles para cirugía plástica</i> |  | 24 - 26 |
| Mikrodissektions-Nadelelektroden <i>Micro-dissection needle electrodes</i> <i>Electrodos aguja para micro disección</i> |  | 27 - 28 |
| Mikrodissektionsnadeln mit Keramikeinsatz <i>Micro-dissection needle with ceramic</i> <i>Agujas de micro disección con cerámica</i> |  | 29 - 30 |
| Arthroskopieelektroden - jetzt auch bipolar <i>Arthroscopy electrodes - now also bipolar</i> <i>Electrodos para artroscopía - bipolares también disponibles</i> |  | 31 - 38 |
| HNO Elektroden <i>ENT electrodes</i> <i>Electrodos ENT (electrodos para coagulación)</i> |  | 39 |
| Laparoskopieelektroden mit Keramikeinsatz <i>Laparoscopy electrodes with ceramic</i> <i>Electrodos para laparoscopia con cerámica</i> |  | 40 - 41 |
| HF-Handgriffe mit und ohne integriertem Kabel <i>HF-pencils with our without integrated cable</i> <i>Lápices HF con o sin cable integrado</i> |  | 42 - 48 |
| HF-Kabel <i>HF cables</i> <i>Cables HF</i> |  | 49 - 52 |
| Neutralelektroden und -kabel <i>neutral electrodes and -cables</i> <i>Electrodos neutros y-cables</i> |  | 53 - 55 |
| HF Pinzetten monopolar und bipolar auch als Antihafteinführung <i>HF forceps monopolar and bipolar</i> as non-stick available <i>Forceps monopolares y bipolares</i> también disponibles en su versión antiadherente |  | 56 - 63 |

Aktive monopolare Elektroden, wiederverwendbar, 4 mm, autoklavierbar 134°C

Active monopolar electrodes, reusable, 4 mm, autoclavable 134°C









Electrodos activos monopolares, reusables, 4 mm con autoclave en 134°C

| Art. Nr. Art. No. Art. N° | Beschreibung Description Descripción | VPE Unit unid. | | |
|---------------------------------|---|----------------------|--|-------------|
| ST-205-0 | Messerelektrode, Länge 3,3 x 25 mm <i>Knife electrode, length 3,3 x 25 mm</i> <i>Electrodo de cuchillo largo 3,3 x 25 mm</i> | 5 |  | Umax: 4 KVp |
| ST-202-0 | Lanzettschneidelektrode, abgewinkelt, feines Blatt, 1,6 x 19 mm <i>Lancet-cutting electrode, angular, fine, 1,6 x 19 mm</i> <i>Electrodo de Lanceta-cortadora angulosa, fina, 1,6 x 19mm</i> | 5 |  | Umax: 4 KVp |
| ST-203-0 | Lanzettschneidelektrode, gerade, 1,6 x 19 mm <i>Lancet-cutting electrode, straight, 1,6 x 19 mm</i> <i>Electrodo de lanceta-cortadora recta, 1,6 x 19mm</i> | 5 |  | Umax: 4 KVp |
| ST-203-9 | Lanzettschneidelektrode, gerade, starkes Blatt, 2,5 x 25 mm <i>Lancet-cutting electrode, straight, strong, 2,5 x 25 mm</i> <i>Electrodo de lanceta-cortadora recta, gruesa, 2,5 x 25mm</i> | 5 |  | Umax: 4 KVp |
| ST-206-0 | Spatelektrode, ovale Form, 3 x 24 mm <i>Spatula electrode, oval shape, 3 x 24 mm</i> <i>Electrodo de espátula forma ovalada, 3 x 24 mm</i> | 5 |  | Umax: 4 KVp |
| ST207-0 | Messerelektrode, seitliche Spitze, 3,3 x 24 mm <i>Knife electrode, 3,3 x 24 mm</i> <i>Electrodo de cuchillo 3,3 x 24 mm</i> | 5 |  | Umax: 4 KVp |
| ST-232-1 | Spatelektrode, biegbar, 2 x 16 mm <i>Spatula electrode, flexible, 2 x 16 mm</i> <i>Electrodo de espátula flexible, 2 x 16 mm</i> | 5 |  | Umax: 4 KVp |

Aktive monopolare Elektroden, wiederverwendbar, 4 mm, autoklavierbar 134°C

Active monopolar electrodes, reusable, 4 mm, autoclavable 134°C









Electrodos activos monopolares, reusables, 4 mm con autoclave en 134°C

| Art. Nr. Art. No. Art. N° | Beschreibung Description Descripción | VPE Unit unid. | | |
|---------------------------------|--|----------------------|--|-------------|
| ST-208-0 | Messerelektrode, abgewinkelt, lanzettenförmig, 1,5 x 17 mm <i>Knife electrode, mangular, lancet, 1,5 x 17 mm</i> <i>Electrodo de cuchillo lanceta,angular, 1,5 x 17 mm</i> | 5 |  | Umax: 4 KVp |
| ST-209-0 | Messerelektrode, lanzettentförmig, 1,5 x 17 mm <i>Knife electrode, lancet, 1,5 x 17 mm</i> <i>Electrodo de cuchillo, lanceta, 1,5 x 17 mm</i> | 5 |  | Umax: 4 KVp |
| ST-205-5 | Messerelektrode, 20 x 2,5 mm <i>Knife electrode, 20 x 2,5 mm</i> <i>Electrodo de cuchillo, 20 x 2,5 mm</i> | 5 |  | Umax: 4 KVp |
| ST-211-8 | Nadelelektrode mit Keramikisolation und Wolframnadel, 5 mm, Ø 0,5 mm <i>Needle electrode with ceramic isolation and tungsten needle, 5 mm, Ø 0,5 mm</i> <i>Electr. de aguja c. aislamiento en cerámica y aguja de tungsteno, 5 mm, Ø 0,5 mm</i> | 1 |  | Umax: 4 KVp |
| ST-210-1 | Nadelelektrode, Ø 0,5 mm <i>Needle electrode, Ø 0,5 mm</i> <i>Electrodo de aguja, Ø 0,5 mm</i> | 5 |  | Umax: 4 KVp |
| ST-210-3 | Nadelelektrode, Ø 0,8 mm <i>Needle electrode, Ø 0,8 mm</i> <i>Electrodo de aguja, Ø 0,8 mm</i> | 5 |  | Umax: 4 KVp |
| ST-211-1 | Nadelelektrode, isoliert, Ø 0,5 mm <i>Needle electrode, insulated, Ø 0,5 mm</i> <i>Electrodo de aguja, aislado, Ø 0,5 mm</i> | 5 |  | Umax: 4 KVp |
| ST-211-2 | Nadelelektrode, isoliert, Ø 0,7 mm <i>Needle electrode, insulated, Ø 0,7 mm</i> <i>Electrodo de aguja, aislado, Ø 0,7 mm</i> | 5 |  | Umax: 4 KVp |
| ST-211-6 | Nadelelektrode, isoliert, Ø 0,7 mm <i>Needle electrode, insulated, Ø 0,7 mm</i> <i>electrodo de aguja aislado, Ø 0,7 mm</i> | 5 |  | Umax: 4 KVp |







Aktive monopolare Elektroden, wiederverwendbar, 4 mm, autoklavierbar 134°C

Active monopolar electrodes, reusable, 4 mm, autoclavable 134°C

Electrodos activos monopolares, reusables, 4 mm con autoclave en 134°C

| Art. Nr. Art. No. Art. N° | Beschreibung Description Descripción | VPE Unit unid. | | |
|---------------------------------|--|----------------------|--|-------------|
| ST-212-1 | Drahtschlingenelektrode, Ø 5 mm <i>Wire loop electrode, Ø 5 mm</i> <i>Electrodo de asa de alambre Ø 5 mm</i> | 5 |  | Umax: 4 KVp |
| ST-212-2 | Drahtschlingenelektrode, Ø 10 mm <i>Wire loop electrode, Ø 10 mm</i> <i>Electrodo de asa de alambre, Ø 10 mm</i> | 5 |  | Umax: 4 KVp |
| ST-213-5 | Bandschlingenelektrode, Ø 12 mm <i>Ribbon loop electrode, Ø 12 mm</i> <i>Electrodo de lazo, Ø 12 mm</i> | 5 |  | Umax: 4 KVp |
| ST-213-8 | Bandschlingenelektrode, Ø 16 mm <i>Ribbon loop electrode, Ø 16 mm</i> <i>Electrodo de lazo, Ø 16 mm</i> | 5 |  | Umax: 4 KVp |
| ST-214-1 | Kugelelektrode, Ø 2 mm <i>Ball electrode, Ø 2 mm</i> <i>Electrodo de bola, Ø 2 mm</i> | 5 |  | Umax: 4 KVp |
| ST-214-2 | Kugelelektrode, Ø 4 mm <i>Ball electrode, Ø 4 mm</i> <i>Electrodo de bola Ø 4 mm</i> | 5 |  | Umax: 4 KVp |
| ST-214-3 | Kugelelektrode, Ø 6 mm <i>Ball electrode, Ø 6 mm</i> <i>Electrodo de bola Ø 6 mm</i> | 5 |  | Umax: 4 KVp |
| ST-214-8 | Kugelelektrode, abgewinkelt, Ø 2 mm <i>Ball electrode, angular, Ø 2 mm</i> <i>Electrodo de bola, anguloso Ø 2 mm</i> | 5 |  | Umax: 4 KVp |
| ST-214-9 | Kugelelektrode, abgewinkelt, Ø 4 mm <i>Ball electrode, angular, Ø 4 mm</i> <i>Electrodo de bola, anguloso Ø 4 mm</i> | 5 |  | Umax: 4 KVp |

Aktive monopolare Elektroden, wiederverwendbar, 4 mm, autoklavierbar 134°C**Active monopolar electrodes, reusable, 4 mm, autoclavable 134°C****Electrodos activos monopolares, reusables, 4 mm, con autoclave en 134° C**

| Art. Nr. Art. No. Art. N° | Beschreibung Description Descripción | VPE Unit unid. | | |
|---------------------------------|---|----------------------|--|-------------|
| ST-223-0 | Wolframelektrode isoliert, gerade, 0,5 x 20 mm <i>Tungsten electrode, insulated, straight, 0,5 x 20 mm</i> <i>Electrodo de Tungsteno, aislado recto 0,5 x 20 mm</i> | 1 |  | Umax: 1 KVp |
| ST-224-0 | Wolframelektrode, isoliert, abgewinkelt, 0,5 x 20 mm <i>Tungsten electrode, insulated, angled, 0,5 x 20 mm</i> <i>Electrodo de Tungsteno, aislado, anguloso, 0,5 x 20 mm</i> | 1 |  | Umax: 1 KVp |
| ST-225-0 | Wolframelektrode isoliert, 0,5 x 40 mm <i>Tungsten electrode, insulated, 0,5 x 40 mm</i> <i>Electrodo de Tungsteno aislado, 0,5 x 40 mm</i> | 1 |  | Umax: 1 KVp |
| ST-226-0 | Wolframelektrode, isoliert, abgewinkelt, 0,5 x 40 mm <i>Tungsten electrode, insulated, angled, 0,5 x 40 mm</i> <i>Electrodo de Tungsteno, aislado, anguloso, 0,5 x 40 mm</i> | 1 |  | Umax: 1 KVp |
| ST-227-0 | Spatelektrode, gerade, ovale Form, 3 x 24 mm <i>Spatula electrode, straight, oval shape, 3 x 24 mm</i> <i>Electrodo de espátula, recta, ovalado, 3 x 24 mm</i> | 1 |  | Umax: 4 KVp |
| ST-216-0 | Nadelelektrode, 29 x 0,8 mm <i>Needle electrode, 29 x 0,8 mm</i> <i>Electrodo de aguja, 29 x 0,8 mm</i> | 1 |  | Umax: 4 KVp |

Aktive monopolare Elektroden, wiederverwendbar, 4 mm, autoklavierbar 134°C

Active monopolar electrodes, reusable, 4 mm, autoclavable 134°C

Electrodos activos monopolares, reusables, 4 mm, con autoclave de 134° C

| Art. Nr. Art. No. Art. N° | Beschreibung Description Descripción | |
|---------------------------------|--|--|
|---------------------------------|--|--|

ST-239-1 Drahtschlingenelektrode, Ø 5 mm VPE 1
 Wire loop electrode, Ø 5 mm Unit 1
 Electrodo de asa de alambre, Ø 5 mm unidad 1
 Umax: 4 KVp



ST-239-2 Drahtschlingenelektrode, Ø 10 mm 100 mm VPE 1
 Wire loop electrode, Ø 10 mm Unit 1
 Electrodo de asa de alambre, Ø 10 mm unidad 1
 Umax: 4 KVp



ST-240-1 Kugelelektrode, Ø 2 mm VPE 1
 Ball electrode, Ø 2 mm Unit 1
 Electrodo de bola, Ø 2 mm 100 mm unidad 1
 Umax: 4 KVp



ST-240-2 Kugelelektrode, Ø 4 mm VPE 1
 Ball electrode, Ø 4 mm Unit 1
 Electrodo de bola, Ø 4 mm 100 mm unidad 1
 Umax: 4 KVp



ST-240-3 Kugelelektrode, Ø 6 mm VPE 1
 Ball electrode, Ø 6 mm Unit 1
 Electrodo de bola, Ø 6 mm 100 mm unidad 1
 Umax: 4 KVp



ST-241-3 Nadelelektrode, 0,8 x 12 mm VPE 1
 Needle electrode, 0,8 x 12 mm Unit 1
 Electrodo de aguja, 0,8 x 12 mm unidad 1
 Umax: 4 KVp



Aktive monopolare Elektroden, wiederverwendbar, 4 mm, autoklavierbar 134°C

Active monopolar electrodes, reusable, 4 mm, autoclavable 134°C

Electrodos activos monopolares, reusables, 4 mm, con autoclave en 134° C

| Art. Nr. Art. No. Art. N° | Beschreibung Description Descripción | |
|---------------------------------|--|--|
|---------------------------------|--|--|

ST-241-6 Nadelelektrode, 0,8 x 12 mm VPE 1
 Needle electrode, 0,8 x 12 mm Unit 1
 Electrodo de aguja, 0,8 x 12 mm unidad 1

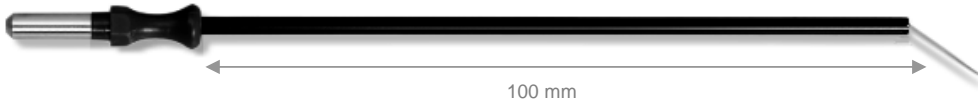

Umax: 4 KVp

ST-242-0 Messerelektrode, 2,4 x 10 mm VPE 1
 Knife electrode, 2,4 x 10 mm Unit 1
 Electrodo de aguja, 2,4 x 10 mm unidad 1



Umax: 4 KVp

ST-243-0 Messerelektrode, abgewinkelt, 2,4 x 10 mm VPE 1
 Knife electrode, angled, 2,4 x 10 mm Unit 1
 Electrodo de cuchillo, anguloso, 2,4 x 10 mm unidad 1



Umax: 4 KVp

ST-242-6 Messerelektrode, 3,3 x 25 mm VPE 1
 Knife electrode, 3,3 x 25 mm Unit 1
 Electrodo de cuchillo, 3,3 x 25 mm unidad 1



Umax: 4 KVp

ST-242-7 Messerelektrode, seitliche Spitze, 3,3 x 20 mm VPE 1
 Knife electrode, 3,3 x 20 mm Unit 1
 Electrodo de cuchillo, 3,3 x 20 mm unidad 1



Umax: 4 KVp

ST-242-8 Messerelektrode, 2,4 x 20 mm VPE 1
 Knife electrode, 2,4 x 20 mm Unit 1
 Electrodo de cuchillo, 2,4 x 20 mm unidad 1



Umax: 4 KVp

Aktive monopolare Elektroden, wiederverwendbar, 4 mm, autoklavierbar 134°C

Active monopolar electrodes, reusable, 4 mm, autoclavable 134°C

Electrodos activos monopolares, reusables, 4 mm, con autoclave en 134° C

| Art. Nr. Art. No. Art. N° | Beschreibung Description Descripción | |
|---------------------------------|--|--|
|---------------------------------|--|--|

| | | |
|----------|---|---|
| ST-244-0 | Lanzettelektrode, 1,6 x 20 mm, feines Blatt <i>Lancet electrode, 1,6 x 20 mm, fine</i> <i>Electrodo de lanceta, 1,6 x 20 mm, fino</i> | VPE 1 <i>Unit 1</i> <i>unidad 1</i> |
|----------|---|---|

Umax: 4 KVp



| | | |
|----------|--|---|
| ST-244-6 | Lanzettelektrode, 2,2 x 20 mm, starkes Blatt <i>Lancet electrode, 2,2 x 20 mm, strong</i> <i>Electrodo de lanceta, 2,2 x 20 mm, grueso</i> | VPE 1 <i>Unit 1</i> <i>unidad 1</i> |
|----------|--|---|

Umax: 4 KVp



← 100 mm →

| | | |
|----------|---|---|
| ST-232-0 | Spatelektrode, 2 x 16 mm, biegsam <i>Spatula electrode, 2 x 16 mm, flexible</i> <i>Electrodo de espátula, 2 x 16 mm, flexible</i> | VPE 1 <i>Unit 1</i> <i>unidad 1</i> |
|----------|---|---|

Umax: 4 KVp



← 55 mm →

Aktive monopolare Elektroden, wiederverwendbar, 4 mm, autoklavierbar 134°C

Active monopolar electrodes, reusable, 4 mm, autoclavable 134°C

Electrodos activos monopolares, reusables, 4 mm, con autoclave en 134° C

| Art. Nr. Art. No. Art. N° | Beschreibung Description Descripción | | |
|---------------------------------|--|--|--|
|---------------------------------|--|--|--|

| | | | |
|----------|---|-----------------------------|---------------|
| ST-246-0 | Schlingenelektrode, 10 x 10 mm Loop electrode, 10 x 10 mm Electrodo de asa de alambre, 10 x 10 mm | VPE 1 Unit 1 unidad 1 | Umax: 0,5 KVp |
|----------|---|-----------------------------|---------------|



| | | | |
|----------|---|-----------------------------|---------------|
| ST-250-1 | Schlingenelektrode, 15 x 15 mm Loop electrode, 15 x 15 mm Electrodo de asa de alambre, 15 x 15 mm | VPE 1 Unit 1 unidad 1 | Umax: 0,5 KVp |
|----------|---|-----------------------------|---------------|



| | | | |
|----------|---|-----------------------------|---------------|
| ST-250-0 | Schlingenelektrode, 15 x 20 mm Loop electrode, 15 x 20 mm Electrodo de asa de alambre, 15 x 20 mm | VPE 1 Unit 1 unidad 1 | Umax: 0,5 KVp |
|----------|---|-----------------------------|---------------|



| | | | |
|----------|--|-----------------------------|---------------|
| ST-251-0 | Schlingenelektrode, 20 x 20 mm Loop electrode, 20 x 20 mm Electrodo de asa de alambre, 20 x 20 | VPE 1 Unit 1 unidad 1 | Umax: 0,5 KVp |
|----------|--|-----------------------------|---------------|

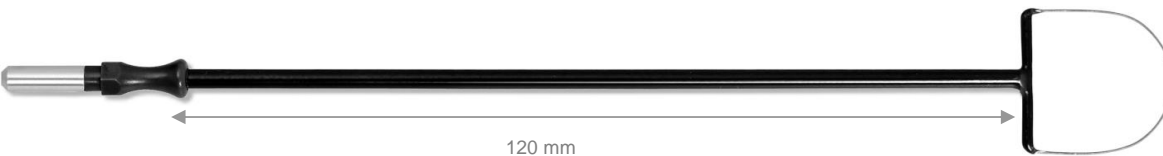

| | | | |
|----------|--|-----------------------------|---------------|
| ST-252-0 | Schlingenelektrode, 20 x 25 mm Loop electrode, 20 x 25 mm Electrodo de asa de alambre 20 x 25 mm | VPE 1 Unit 1 unidad 1 | Umax: 0,5 KVp |
|----------|--|-----------------------------|---------------|

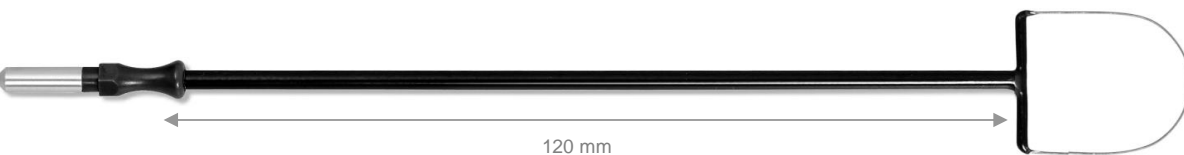

Aktive monopolare Elektroden, wiederverwendbar, 4 mm, autoklavierbar 134°C**Active monopolar electrodes, reusable, 4 mm, autoclavable 134°C****Electrodos activos monopolares, reusables, 4 mm, con autoclave en 134° C**

| Art. Nr. Art. No. Art. N° | Beschreibung Description Descripción | | |
|---------------------------------|--|--|--|
|---------------------------------|--|--|--|

| | | | |
|----------|--|-----------------------------|---------------|
| ST-258-0 | Schlingenelektrode, Ø 10 mm Loop electrode, Ø 10 mm Electrodo de lazo, Ø 10 mm | VPE 1 Unit 1 unidad 1 | Umax: 0,5 KVp |
|----------|--|-----------------------------|---------------|



| | | | |
|----------|--|-----------------------------|---------------|
| ST-259-0 | Schlingenelektrode, Ø 15 mm Loop electrode, Ø 15 mm Electrodo de lazo, Ø 15 mm | VPE 1 Unit 1 unidad 1 | Umax: 0,5 KVp |
|----------|--|-----------------------------|---------------|



| | | | |
|----------|--|-----------------------------|---------------|
| ST-260-0 | Schlingenelektrode, Ø 20 mm Loop electrode, Ø 20 mm Electrodo de lazo, Ø 20 mm | VPE 1 Unit 1 unidad 1 | Umax: 0,5 KVp |
|----------|--|-----------------------------|---------------|



| | | | |
|----------|--|-----------------------------|---------------|
| ST-261-0 | Schlingenelektrode, Ø 25 mm Loop electrode, Ø 25 mm Electrodo de lazo, Ø 25 mm | VPE 1 Unit 1 unidad 1 | Umax: 0,5 KVp |
|----------|--|-----------------------------|---------------|

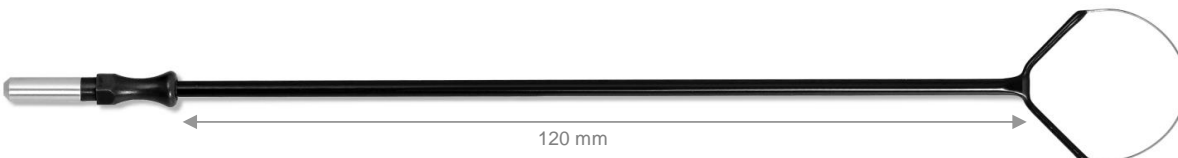

| | | | |
|----------|--|-----------------------------|---------------|
| ST-268-0 | Schlingenelektrode, Ø 30 mm Loop electrode, Ø 30 mm Electrodo de lazo, Ø 30 mm | VPE 1 Unit 1 unidad 1 | Umax: 0,5 KVp |
|----------|--|-----------------------------|---------------|

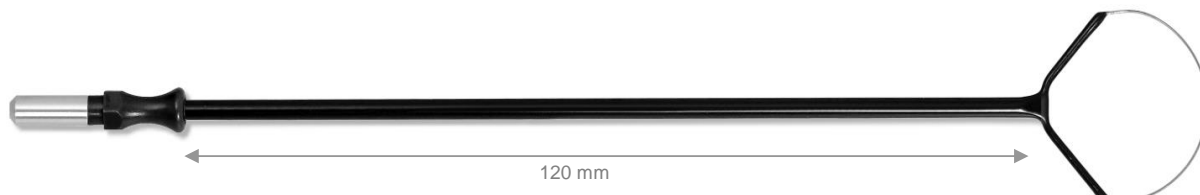

Aktive monopolare Elektroden, wiederverwendbar, 4 mm, autoklavierbar 134°C

Active monopolar electrodes, reusable, 4 mm, autoclavable 134°C

Electrodos monopolares activos, reusables, 4 mm, con autoclave en 134°C

| Art. Nr. Art. No. Art. N° | Beschreibung Description Descripción | |
|---------------------------------|--|--|
|---------------------------------|--|--|

| | | |
|----------|---|-----------------------------|
| ST-264-0 | Schlingenelektrode, 10 x 25 mm Loop electrode, 10 x 25 mm Electrodo de lazo, 10 x 25 mm | VPE 1 Unit 1 unidad 1 |
|----------|---|-----------------------------|

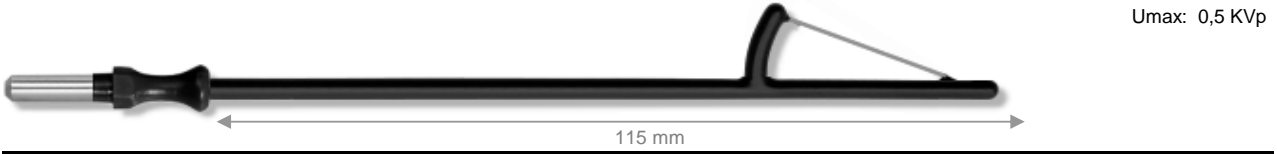

| | | |
|----------|---|-----------------------------|
| ST-262-0 | Schlingenelektrode, 15 x 25 mm Loop electrode, 15 x 25 mm Electrodo de lazo, 15 x 25 mm | VPE 1 Unit 1 unidad 1 |
|----------|---|-----------------------------|

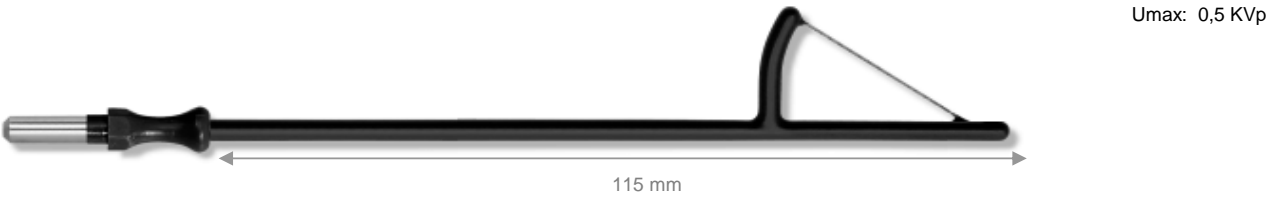

| | | |
|----------|---|-----------------------------|
| ST-263-0 | Schlingenelektrode, 20 x 25 mm Loop electrode, 20 x 25 mm Electrodo de lazo, 20 x 25 mm | VPE 1 Unit 1 unidad 1 |
|----------|---|-----------------------------|



Aktive monopolare Elektroden, wiederverwendbar, 4 mm, autoklavierbar 134°C

Active monopolar electrodes, reusable, 4 mm, autoclavable 134°C

Electrodos monopolares activos, reusables, 4 mm, con autoclave en 134° C

| Art. Nr. Art. No. Art. N° | Beschreibung Description Descripción | |
|---------------------------------|--|--|
|---------------------------------|--|--|

| | | |
|----------|---|-----------------------------|
| ST-270-0 | Koagulationsnadel, Ø 1,2 mm Koagulation needle, Ø 1,2 mm Aguja de coagulación, Ø 1,2 mm | VPE 1 Unit 1 unidad 1 |
|----------|---|-----------------------------|



Umax: 0,5 KVp

| | | |
|----------|---|-----------------------------|
| ST-271-0 | Kugelelektrode, Ø 2 mm Ball electrode, Ø 2 mm Electrodo de bola, Ø 2 mm | VPE 1 Unit 1 unidad 1 |
|----------|---|-----------------------------|



Umax: 0,5 KVp

Aktive monopolare Elektroden, wiederverwendbar, 4 mm, autoklavierbar 134°C**Active monopolar electrodes, reusable, 4 mm, autoclavable 134°C****Electrodos monopolares activos, reusables, 4 mm, con autoclave en 134° C**

| Art. Nr. | Beschreibung | |
|----------|--------------|--|
| Art. No. | Description | |
| Art. N° | Descripción | |

Umax: 4 KVp











| | | |
|----------|--|-----------------------------|
| ST-274-4 | Elektrodenverlängerung, 80 mm, für 4 mm Schaft, mit Federkorb <i>Extension for electrodes, 80 mm, for 4 mm shaft, with cage</i> <i>Extensión p. electrodos, 80 mm, con eje de 4 mm, con cesta</i> | VPE 1 Unit 1 unidad 1 |
| ST-274-5 | Elektrodenverlängerung, 100 mm, für 4 mm Schaft, mit Federkorb <i>Extension for electrodes, 100 mm, for 4 mm shaft, with cage</i> <i>Extensión para electrodos, 100 mm, con eje de 4 mm, con cesta</i> | VPE 1 Unit 1 unidad 1 |
| ST-274-6 | Elektrodenverlängerung, 150 mm, für 4 mm Schaft, mit Federkorb <i>Extension for electrodes, 150 mm, for 4 mm shaft, with cage</i> <i>Extensión para electrodos, 150 mm, con eje de 4 mm, con cesta</i> | VPE 1 Unit 1 unidad 1 |
| ST-293-5 | Spannzange, von 4 mm auf 2,4 mm <i>Chuck, from 4 mm to 2,4 mm</i> <i>Cortador, de 4 mm a 1,6 mm</i> | VPE 1 Unit 1 unidad 1 |
| ST-293-6 | Spannzange, von 4 mm auf 1,6 mm <i>Chuck, from 4 mm to 1,6 mm</i> <i>Cortador, de 4 mm a 1,6 mm</i> | VPE 1 unidad 1 Unit 1 |



Aktive monopolare Stahl-Elektroden, wiederverwendbar, 4 mm, autoklavierbar 134°C

Active monopolar steel-electrodes, reusable, 4 mm, autoclavable 134°C



Electrodos de acero activos monopolares, reusables, 4 mm, con autoclave en 134°C

| Art. Nr. Art. No. Art. N° | Beschreibung Description Descripción | VPE Unit unid. | |
|---------------------------------|--|----------------------|--|
| ST-101-0 | Lanzettelektrode, gerade, 25 x 2,4 mm <i>Lancet electrode, straight, 25 x 2,4 mm</i> <i>Electrodo de lanceta, recto, 25 x 2,4 mm</i> | 5 |  |
| ST-102-0 | Lanzettelektrode, abgewinkelt <i>Electrodo de lanceta, angular</i> <i>Lancet electrode, angular</i> | 5 |  |
| ST-104-0 | Messerelektrode, 25 x 3,2 mm <i>Knife electrode, 25 x 3,2 mm</i> <i>Electrodo de cuchillo, 25 x 3,2 mm</i> | 5 |  |
| ST-105-0 | Messerelektrode <i>Knife electrode</i> <i>Electodo de cuchillo</i> | 5 |  |
| ST-109-0 | Ø 5 mm Drahtschlingenelektrode <i>Wire loop electrode</i> <i>Electrodo de asa de alambre</i> | 5 |  |
| ST-110-0 | Ø 10 mm | | |
| ST-112-0 | Ø 10 mm Bandschlingenelektrode, <i>Ribbon loop electrode,</i> <i>Electrodo de lazo,</i> | 5 |  |
| ST-113-0 | Ø 15 mm | | |
| ST-114-0 | Ø 2,5 mm Kugelelektrode <i>Electrodo de bola</i> <i>Ball electrode</i> | 5 |  |
| ST-115-0 | Ø 4 mm | | |
| ST-116-0 | Ø 5 mm | | |
| ST-108-0 | L = 22 mm Nadelelektrode <i>Needle electrode</i> <i>Electrodo de aguja</i> | 5 |  |
| ST-108-1 | L = 30 mm | | |

Aktive monopolare Elektroden, wiederverwendbar, 2,4 mm, autoklavierbar 134°C**Active monopolar electrodes, reusable, 2,4 mm, autoclavable 134°C****Electrodos monopolares activos, reusables, 2,4 mm, con autoclave en 134° C**

| Art. Nr. Art. No. Art. N° | Beschreibung Description Descripción | VPE Unit unid. | | |
|---------------------------------|--|----------------------|--|-------------|
| ST-300-0 | Spatelektrode, 2,5 x 20 mm <i>Spatulaelectrode, 2,5 x 20 mm</i> <i>Electrodo de espátula, 2,5 x 20 mm</i> | 5 |  | Umax: 4 KVp |
| ST-301-0 | Schneidelektrode, 2,5 x 20 mm <i>Blade electrode, 2,5 x 20 mm</i> <i>Electrodo de cuchillo de hoja, 2,5 x 20 mm</i> | 5 |  | Umax: 4 KVp |
| ST-305-1 | Kugelelektrode, Ø 2,0 mm <i>Ball electrode, Ø 2,0 mm</i> <i>Electrodo de bola, Ø 2,0 mm</i> | 5 |  | Umax: 4 KVp |
| ST-305-2 | Kugelelektrode, Ø 4,0 mm <i>Ball electrode, Ø 4,0 mm</i> <i>Electrodo de bola, Ø 4,0 mm</i> | 5 |  | Umax: 4 KVp |
| ST-305-3 | Kugelelektrode, Ø 6,0 mm <i>Ball electrode, Ø 6,0 mm</i> <i>Electrodo de bola, Ø 6,0 mm</i> | 5 |  | Umax: 4 KVp |
| ST-305-8 | Kugelelektrode, abgewinkelt, Ø 2,0 mm <i>Ball electrode, angular, Ø 2,0 mm</i> <i>Electrodo de bola, angular Ø 2,0 mm</i> | 5 |  | Umax: 4 KVp |
| ST-305-9 | Kugelelektrode, abgewinkelt, Ø 4,0 mm <i>Ball electrode, angular, Ø 4,0 mm</i> <i>Electrodo de bola, angular, Ø 4,0 mm</i> | 5 |  | Umax: 4 KVp |





Aktive monopolare Elektroden, wiederverwendbar, 2,4 mm, autoklavierbar 134°C**Active monopolar electrodes, reusable, 2,4 mm, autoclavable 134°C****Electrodos monopolares activos, reusables, 2,4 mm, con autoclave en 134° C**

| Art. Nr. Art. No. Art. N° | Beschreibung Description Descripción | VPE Unit unid. | | |
|---------------------------------|--|----------------------|--|-------------|
| ST-306-1 | Drahtschlingenelektrode, Ø 5 mm Wire loop electrode, Ø 5 mm Electrodo de asa de alambre, Ø 5 mm | 5 |  | Umax: 4 KVp |
| ST-306-2 | Drahtschlingenelektrode, Ø 10 mm Wire loop electrode, Ø 10 mm Electrodo de asa de alambre, Ø 10 mm | 5 |  | Umax: 4 KVp |
| ST-306-3 | Drahtschlingenelektrode, Ø 14 mm Wire loop electrode, Ø 14 mm Electrodo de asa de alambre, Ø 14 mm | 5 |  | Umax: 4 KVp |
| ST-307-2 | Bandschlingenelektrode, Ø 10 mm Ribbon loop electrode, Ø 10 mm Electrodo de lazo, Ø 10 mm | 5 |  | Umax: 4 KVp |
| ST-307-3 | Bandschlingenelektrode, Ø 14 mm Ribbon loop electrode, Ø 14 mm Electrodo de lazo, Ø 14 mm | 5 |  | Umax: 4 KVp |

Aktive monopolare Elektroden, wiederverwendbar, 2,4 mm, autoklavierbar 134°C

Active monopolar electrodes, reusable, 2,4 mm, autoclavable 134°C

Electrodos monopolares activos, reusables, 2,4 mm, con autoclave en 134° C

| Art. Nr. Art. No. Art. N° | Beschreibung Description Descripción | VPE Unit unid. | | |
|---------------------------------|--|----------------------|--|-------------|
| ST-303-1 | Nadelelektrode, Ø 0,5 / 0,5 x 20 mm Needle electrode, Ø 0,5 / 0,5 x 20 mm Electrodo de aguja, Ø 0,5 / 0,5 x 20 mm | 5 |  | Umax: 4 KVp |
| ST-303-2 | Nadelelektrode, Ø 0,5 / 0,7 x 20 mm Needle electrode, Ø 0,5 / 0,7 x 20 mm Electrodo de aguja, Ø 0,5 / 0,7 x 20 mm | 5 |  | Umax: 4 KVp |
| ST-323-0 | Wolframelektrode isoliert, gerade, 0,5 x 20 mm Tungsten electrode, insulated, straight, 0,5 x 20 mm Electrodo de Tungsteno, aislado, recto, 0,5 x 20 mm | 1 |  | Umax: 1 KVp |
| ST-324-0 | Wolframelektrode, isoliert, abgewinkelt, 0,5 x 20 mm Tungsten electrode, insulated, angled, 0,5 x 20 mm Electrodo de Tungsteno, aislado, anguloso, 0,5 x 20 mm | 1 |  | Umax: 1 KVp |
| ST-303-8 | Nadelelektrode mit Keramikisolation und Wolframnadel, 5 mm, Ø 0,5 mm Needle electrode with ceramic isolation and tungsten needle, 5 mm, Ø 0,5 mm Electr. de aguja con aislante en cerámica y aguja de tungsteno, 5 mm, Ø 0,5 mm | 1 |  | Umax: 1 KVp |

Aktive monopolare Elektroden, wiederverwendbar, 2,4 mm, autoklavierbar 134°C

Active monopolar electrodes, reusable, 2,4 mm, autoclavable 134°C

Electrodos monopolares activos, reusables, 2,4 mm, con autoclave en 134° C

| Art. Nr. Art. No. Art. N° | Beschreibung Description Descripción | | | |
|---------------------------------|---|-----------------------------|-------------|--|
| ST-344-1 | Kugelelektrode, Ø 2,0 mm Ball electrode, Ø 2,0 mm Electrodo de bola, Ø 2,0 mm | VPE 1 Unit 1 unidad 1 | Umax: 4 KVp |  |
| ST-344-2 | Kugelelektrode, Ø 4,0 mm Ball electrode, Ø 4,0 mm Electrodo de bola, Ø 4,0 mm | VPE 1 Unit 1 unidad 1 | Umax: 4 KVp |  |
| ST-340-0 | Spatelelektrode, 2,5 x 20 mm Spatula electrode, 2,5 x 20 mm Electrodo de espátula, 2,5 x 20 mm | VPE 1 Unit 1 unidad 1 | Umax: 4 KVp |  |
| ST-341-0 | Schneidelektrode, isoliert, 2,5 x 20 mm Blade electrode, insulated, 2,5 x 20 mm Electrodo de bola, aislado, 2,5 x 20 mm | VPE 1 Unit 1 unidad 1 | Umax: 4 KVp |  |
| ST-342-1 | Nadelelektrode, Ø 0,5 / 0,5 x 12 mm Needle electrode, Ø 0,5 / 0,5 x 12 mm Electrodo de aguja, Ø 0,5 / 0,5 x 12 mm | VPE 1 Unit 1 unidad 1 | Umax: 4 KVp |  |
| ST-342-2 | Nadelelektrode, Ø 0,7 / 0,5 x 12 mm Needle electrode, Ø 0,7 / 0,5 x 12 mm Electrodo de aguja, Ø 0,7 / 0,5 x 12 mm | VPE 1 Unit 1 unidad 1 | Umax: 4 KVp |  |

Aktive monopolare Elektroden, wiederverwendbar, 2,4 mm, autoklavierbar 134°C

Active monopolar electrodes, reusable, 2,4 mm, autoclavable 134°C

Electrodos monopolares activos, reusables, 2,4 mm, con autoclave en 134° C

| Art. Nr. Art. No. Art. N° | Beschreibung Description Descripción |
|---------------------------------|--|
|---------------------------------|--|



Umax: 4 KVp

| | | |
|----------|---|---|
| ST-374-4 | Elektrodenverlängerung, 70 mm, für 2,4 mm Schaft, mit Federkorb <i>Extension for electrodes, 70 mm, for 2,4 mm shaft, with cage</i> <i>Extensión para electrodos, 70 mm, con eje de 2,4 mm, con cesta</i> | VPE 1 <i>Unit 1</i> <i>unidad 1</i> |
|----------|---|---|

| | | |
|----------|---|---|
| ST-374-5 | Elektrodenverlängerung, 90 mm, für 2,4 mm Schaft, mit Federkorb <i>Extension for electrodes, 90 mm, for 2,4 mm shaft, with cage</i> <i>Extensión de electrodos, 90 mm, con eje de 2,4 mm, con cesta</i> | VPE 1 <i>Unit 1</i> <i>unidad 1</i> |
|----------|---|---|

| | | |
|----------|--|---|
| ST-374-6 | Elektrodenverlängerung, 140 mm, für 2,4 mm Schaft, mit Federkorb <i>Extension for electrodes, 140 mm, for 2,4 mm shaft, with cage</i> <i>Extensión de electrodos, 140 mm, con eje de 2,4 mm, con cesta</i> | VPE 1 <i>Unit 1</i> <i>unidad 1</i> |
|----------|--|---|

| | | |
|----------|--|---|
| ST-364-0 | Schlingenelektrode, 10 x 25 mm <i>Loop electrode, 10 x 25 mm</i> <i>Electrodo de lazo, 10 x 25</i> | VPE 1 <i>Unit 1</i> <i>unidad 1</i> |
|----------|--|---|



Umax: 0,5 KVp

| | | |
|----------|---|---|
| ST-362-0 | Schlingenelektrode, 15 x 25 mm <i>Loop electrode, 15 x 25 mm</i> <i>Electrodo de lazo, 15 x 25 mm</i> | VPE 1 <i>Unit 1</i> <i>unidad 1</i> |
|----------|---|---|



Umax: 0,5 KVp

| | | |
|----------|---|---|
| ST-363-0 | Schlingenelektrode, 20 x 25 mm <i>Loop electrode, 20 x 25 mm</i> <i>Electrodo de lazo, 20 x 25 mm</i> | VPE 1 <i>Unit 1</i> <i>unidad 1</i> |
|----------|---|---|



Umax: 0,5 KVp

Aktive monopolare Elektroden, wiederverwendbar, 2,4 mm, autoklavierbar 134°C

Active monopolar electrodes, reusable, 2,4 mm, autoclavable 134°C

Electrodos monopolares activos, reusables, 2,4 mm, con autoclave en 134° C

| Art. Nr. Art. No. Art. N° | Beschreibung Description Descripción | |
|---------------------------------|--|--|
|---------------------------------|--|--|

| | | | |
|----------|---|-----------------------------|---------------|
| ST-346-0 | Schlingenelektrode, 10 x 10 mm Loop electrode, 10 x 10 mm Electrodo de lazo, 10 x 10 mm | VPE 1 Unit 1 unidad 1 | Umax: 0,5 KVp |
|----------|---|-----------------------------|---------------|



| | | | |
|----------|---|-----------------------------|---------------|
| ST-350-1 | Schlingenelektrode, isoliert, 15 x 15 mm Loop electrode, insulated, 15 x 15 mm Electrodo de lazo, aislado, 15 x 15 mm | VPE 1 Unit 1 unidad 1 | Umax: 0,5 KVp |
|----------|---|-----------------------------|---------------|



| | | | |
|----------|---|-----------------------------|---------------|
| ST-350-0 | Schlingenelektrode, isoliert, 15 x 20 mm Loop electrode, insulated, 15 x 20 mm Electrodo de lazo, aislado, 15 x 20 mm | VPE 1 Unit 1 unidad 1 | Umax: 0,5 KVp |
|----------|---|-----------------------------|---------------|



| | | | |
|----------|---|-----------------------------|---------------|
| ST-351-0 | Schlingenelektrode, 20 x 20 mm Loop electrode, 20 x 20 mm Electrodo de lazo, 20 x 20 mm | VPE 1 Unit 1 unidad 1 | Umax: 0,5 KVp |
|----------|---|-----------------------------|---------------|



| | | | |
|----------|---|-----------------------------|---------------|
| ST-352-0 | Schlingenelektrode, 26 x 20 mm Loop electrode, 26 x 20 mm Electrodo de lazo, 26 x 20 mm | VPE 1 Unit 1 unidad 1 | Umax: 0,5 KVp |
|----------|---|-----------------------------|---------------|

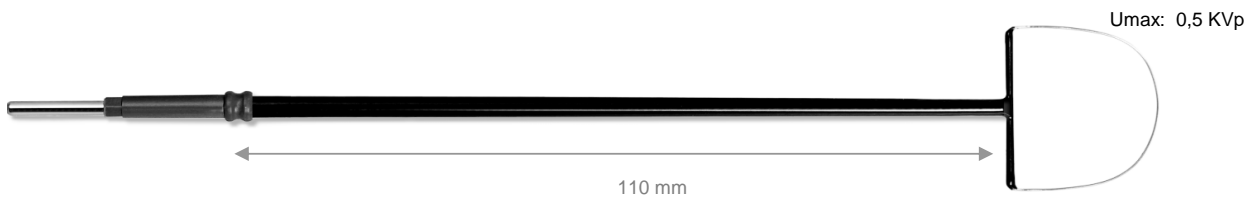

Aktive monopolare Elektroden, wiederverwendbar, 2,4 mm, autoklavierbar 134°C

Active monopolar electrodes, reusable, 2,4 mm, autoclavable 134°C

Electrodos monopolares activos, reusables 2,4 mm, con autoclave en 134° C

| Artikel-Nr. Art. No. Art. N° | Beschreibung Description Descripción | |
|------------------------------------|--|--|
|------------------------------------|--|--|

| | | |
|----------|--|-----------------------------|
| ST-358-0 | Schlingenelektrode, Ø 10 mm Loop electrode, Ø 10 mm Electrodo de lazo, Ø 10 mm | VPE 1 Unit 1 unidad 1 |
|----------|--|-----------------------------|



| | | |
|----------|--|-----------------------------|
| ST-359-0 | Schlingenelektrode, Ø 15 mm Loop electrode, Ø 15 mm Electrodo de lazo, Ø 15 mm | VPE 1 Unit 1 unidad 1 |
|----------|--|-----------------------------|



| | | |
|----------|--|-----------------------------|
| ST-360-0 | Schlingenelektrode, Ø 20 mm Loop electrode, Ø 20 mm Electrodo de lazo, Ø 20 mm | VPE 1 Unit 1 unidad 1 |
|----------|--|-----------------------------|













| | | |
|----------|--|-----------------------------|
| ST-361-0 | Schlingenelektrode, Ø 25 mm Loop electrode, Ø 25 mm Electrodo de lazo, Ø 25 mm | VPE 1 Unit 1 unidad 1 |
|----------|--|-----------------------------|



110 010









Monopolare Elektroden für Dental und Kosmetik, wiederverwendbar, Schaft 1,6 mm
Monopolar electrodes for dental and cosmetic applications, reusable, shaft 1,6 mm
Electrodos monopolares activos para Odontología y Cosmética, reusables, con eje 1,6 mm

| Art. Nr. Art. No. Art. N° | Beschreibung Description Descripción | VPE Unit unid. | | |
|---------------------------------|--|----------------------|--|-------------|
| ST-404-0 | Drahtschlingenelektrode, Ø 3 mm Wire loop electrode, Ø 3 mm Electrodo de asa de alambre, Ø 3 mm | 5 |  | Umax: 1 KVp |
| ST-405-0 | Drahtschlingenelektrode, Ø 5 mm Wire loop electrode, Ø 5 mm Electrodo de asa de alambre, Ø 5 mm | 5 |  | Umax: 1 KVp |
| ST-406-0 | Drahtschlingenelektrode, Ø 8 mm Wire loop electrode, Ø 8 mm Electrodo de asa de alambre, Ø 8 mm | 5 |  | Umax: 1 KVp |
| ST-401-0 | Nadelelektrode, 0,2 mm Needle electrode, 0,2 mm Electrodo de aguja, 0,2 mm | 5 |  | Umax: 1 KVp |
| ST-402-0 | Nadelelektrode, abgewinkelt 45° Needle electrode, angled 45° Electrodo de aguja, con ángulo a 45° | 5 |  | Umax: 1 KVp |
| ST-416-0 | Koagulations-Nadelelektrode Coagulation - Needle electrode Electrodo de aguja para coagulación | 5 |  | Umax: 1 KVp |
| ST-417-0 | Kugelelektrode, Ø 1,7 mm Ball electrode, Ø 1,7 mm Electrodo de bola, Ø 1,7 mm | 5 |  | Umax: 1 KVp |
| ST-417-1 | Kugelelektrode, Ø 1,7 mm Ball electrode, Ø 1,7 mm Electrodo de bola, Ø 1,7 mm | 5 |  | Umax: 1 KVp |
| ST-418-0 | Kugelelektrode, Ø 3 mm, abgewinkelt 45° Ball electrode, Ø 3 mm, angled 45° Electrodo de bola, Ø 3 mm, con ángulo a 45° | 5 |  | Umax: 1 KVp |
| ST-418-1 | Kugelelektrode, Ø 3 mm Ball electrode, Ø 3 mm Electrodo de bola, Ø 3 mm | 5 |  | Umax: 1 KVp |
| ST-419-0 | Koagulations- und Fulgurationselektrode Electrode, coagulating and fulguration Electrodo de coagulación y fulguración | 5 |  | Umax: 1 KVp |

Elektroden für die plastische Chirurgie, wiederverwendbar, 2,4 mm, autoclavierbar 134°C

Electrodes for the plastic surgery, reusable, 2,4 mm, autoclavable 134°C









Electrodos para cirugía plástica, reusables, 2,4 mm, con autoclave en 134°C

| Art. Nr. Art. No. Art. N° | Beschreibung Description Descripción | VPE Unit unid. | | |
|---------------------------------|---|----------------------|--|-------------|
| ST-390-0 | Nadelelektrode, biegsam, Wolfram 0,25 mm <i>Needle electrode, flexible, tungsten 0,25 mm</i> <i>Electrodo de aguja, flexible, de tungsteno, 0,25 mm</i> | 5 |  | Umax: 2 KVp |
| ST-384-0 | Drahtschlingenelektrode, dreiecksförmig, 7 mm, biegsam, Wolfram 0,2 mm <i>Wire loop electrode, triangular shape, 7 mm, flexible, tungsten 0,2 mm</i> <i>Electr. d.a.d. alambre, c. forma triangular 7mm, flexible de tungsteno 0,2 mm</i> | 5 |  | Umax: 2 KVp |
| ST-384-1 | Drahtschlingenelektrode, dreiecksförmig, 9 mm, biegsam, Wolfram 0,2 mm <i>Wire loop electrode, triangular shape, 9 mm, flexible, tungsten 0,2 mm</i> <i>Electr. d. a. d. alambre, c. forma triangular 9 mm, flexible de tungsteno 0,2 mm</i> | 5 |  | Umax: 2 KVp |
| ST-384-2 | Drahtschlingenelektrode, rhombusförmig, biegsam, Wolfram 0,2 mm <i>Wire loop electrode, rhombic shape, flexible, tungsten 0,2 mm</i> <i>Electr. d. a. d. alambre, c. forma de rombo flexible de tungsteno 0,2 mm</i> | 5 |  | Umax: 2 KVp |
| ST-384-3 | Drahtschlingenelektrode, Ø 5 mm, biegsam, Wolfram 0,2 mm <i>Wire loop electrode, Ø 5 mm, flexible, tungsten 0,2 mm</i> <i>Electrodo de asa de asa de alambre, Ø 5 mm, flexible, de tungsteno de 0,2 mm</i> | 5 |  | Umax: 2 KVp |
| ST-384-4 | Drahtschlingenelektrode, Ø 8 mm, biegsam, Wolfram 0,2 mm <i>Wire loop electrode, Ø 8 mm, flexible, tungsten 0,2 mm</i> <i>Electrodo de asa de alambre, Ø 8 mm, flexible de tungsteno de 0,2 mm</i> | 5 |  | Umax: 2 KVp |
| ST-381-0 | Kugelelektrode, Ø 1 mm, biegsam <i>Ball electrode, Ø 1 mm, flexible</i> <i>Electrodo de Bola Ø 1 mm, flexible</i> | 5 |  | Umax: 2 KVp |
| ST-383-0 | Kugelelektrode Ø 3 mm, biegsam <i>Ball electrode Ø 3 mm, flexible</i> <i>Electrodo de bola Ø 3 mm, flexible</i> | 5 |  | Umax: 2 KVp |
| ST-382-0 | Spatelektrode, biegsam <i>Spatula electrode, flexible</i> <i>Electrodo de espátula, flexible</i> | 5 |  | Umax: 2 KVp |

Elektroden für die plastische Chirurgie, wiederverwendbar, 4 mm, autoklavierbar 134°C

Electrodes for the plastic surgery, reusable, 4 mm, autoclavable 134°C









Electrodos para cirugía plástica, reusables, 4 mm, con autoclave en 134° C

| Art. Nr. Art. No. Art. N° | Beschreibung Description Descripción | VPE Unit unid. | | |
|---------------------------------|---|----------------------|--|-------------|
| ST-290-0 | Nadelelektrode, biegsam, Wolfram 0,25 mm <i>Needle electrode, flexible, tungsten 0,25 mm</i> <i>Electrodo de aguja, flexible, de tungsteno 0,25 mm</i> | 5 |  | Umax: 2 KVp |
| ST-284-0 | Drahtschlingenelektrode, dreiecksförmig, 7 mm, biegsam, Wolfram 0,2 mm <i>Wire loop electrode, triangular shape, 7 mm, flexible, tungsten 0,2 mm</i> <i>Electr. d. a. d. alambre, c. forma triangular 7mm, flexible, de tungsteno 0,2 mm</i> | 5 |  | Umax: 2 KVp |
| ST-284-1 | Drahtschlingenelektrode, dreiecksförmig, 9 mm, biegsam, Wolfram 0,2 mm <i>Wire loop electrode, triangular shape, 9 mm, flexible, tungsten 0,2 mm</i> <i>Electr. de asa de alambre, flexible d. 9 mm, de tungsteno de 0,2 mm</i> | 5 |  | Umax: 2 KVp |
| ST-284-2 | Drahtschlingenelektrode, rhombusförmig, biegsam, Wolfram 0,2 mm <i>Wire loop electrode, rhombic shape, flexible, tungsten 0,2 mm</i> <i>Electr. d. a. d. alambre, c. forma de rombo, flexible de tungsteno de 0,2 mm</i> | 5 |  | Umax: 2 KVp |
| ST-284-3 | Drahtschlingenelektrode, Ø 5 mm, biegsam, Wolfram 0,2 mm <i>Wire loop electrode, Ø 5 mm, flexible, tungsten 0,2 mm</i> <i>Electrodo de asa de alambre, Ø 5 mm, flexible, de tungsteno de 0,2 mm</i> | 5 |  | Umax: 2 KVp |
| ST-284-4 | Drahtschlingenelektrode, Ø 8 mm, biegsam, Wolfram 0,2 mm <i>Wire loop electrode, Ø 8 mm, flexible, tungsten 0,2 mm</i> <i>Electrodo de asa de alambre, Ø 8 mm, flexible de tungsteno de 0,2 mm</i> | 5 |  | Umax: 2 KVp |
| ST-281-0 | Kugelelektrode, Ø 1 mm, biegsam <i>Ball electrode, Ø 1 mm, flexible</i> <i>Electrodo de bola, Ø 1 mm, flexible</i> | 5 |  | Umax: 2 KVp |
| ST-283-0 | Kugelelektrode Ø 3 mm, biegsam <i>Ball electrode Ø 3 mm, flexible</i> <i>Electrodo de bola, Ø 3 mm, flexible</i> | 5 |  | Umax: 2 KVp |
| ST-282-0 | Spatelelektrode, biegsam <i>Spatula electrode, flexible</i> <i>Electrodo de espátula, flexible</i> | 5 |  | Umax: 2 KVp |

Elektroden für die plastische Chirurgie, wiederverwendbar, 1,6 mm, autoklavierbar 134°C

Electrodes for the plastic surgery, reusable, 1,6 mm, autoclavable 134°C

Electrodos para Cirugía plástica, reusables, 1,6 mm, con autoclave en 134° C

| Art. Nr. Art. No. Art. N° | Beschreibung Description Descripción | VPE Unit unid. | | |
|---------------------------------|---|----------------------|--|-------------|
| ST-490-0 | Nadelelektrode, biegsam, Wolfram 0,25 mm <i>Needle electrode, flexible, tungsten 0,25 mm</i> <i>Electrodo de aguja flexible, tungsteno 0,25 mm</i> | 5 |  | Umax: 2 KVp |
| ST-484-0 | Drahtschlingenelektrode, dreiecksförmig, 7 mm, biegsam, Wolfram 0,2 mm <i>Wire loop electrode, triangular shape, 7 mm, flexible, tungsten 0,2 mm</i> <i>Electr. d. a. d. alambre, c. forma triangular 7mm, flexible, tugsteno 0,2 mm</i> | 5 |  | Umax: 2 KVp |
| ST-484-1 | Drahtschlingenelektrode, dreiecksförmig, 9 mm, biegsam, Wolfram 0,2 mm <i>Wire loop electrode, triangular shape, 9 mm, flexible, tungsten 0,2 mm</i> <i>Electr. d. a. d. alambre, c. forma triangular de 9 mm, flexible, tugsteno 0,2 mm</i> | 5 |  | Umax: 2 KVp |
| ST-484-2 | Drahtschlingenelektrode, rhombusförmig, biegsam, Wolfram 0,2 mm <i>Wire loop electrode, rhombic shape, flexible, tungsten 0,2 mm</i> <i>Electr. d. a. d. alambre, c. forma de rombo, flexible, tugsteno 0,2 mm</i> | 5 |  | Umax: 2 KVp |
| ST-484-3 | Drahtschlingenelektrode, Ø 5 mm, biegsam, Wolfram 0,2 mm <i>Wire loop electrode, Ø 5 mm, flexible, tungsten 0,2 mm</i> <i>Electrodo de asa de alambre, Ø 5mm, flexible, tugsteno 0,2 mm</i> | 5 |  | Umax: 2 KVp |
| ST-484-4 | Drahtschlingenelektrode, Ø 8 mm, biegsam, Wolfram 0,2 mm <i>Wire loop electrode, Ø 8 mm, flexible, tungsten 0,2 mm</i> <i>Electrodo de asa de alambre, Ø 8 mm, flexible, tugsteno 0,2 mm</i> | 5 |  | Umax: 2 KVp |
| ST-481-0 | Kugelelektrode, Ø 1 mm, biegsam <i>Ball electrode, Ø 1 mm, flexible</i> <i>Electrodo de bola, Ø 1 mm, flexible</i> | 5 |  | Umax: 2 KVp |
| ST-468-0 | Kugelelektrode Ø 3 mm, biegsam <i>Ball electrode Ø 3 mm, flexible</i> <i>Electrodo de bola, Ø 3 mm, flexible</i> | 5 |  | Umax: 2 KVp |
| ST-482-0 | Spatelelektrode, biegsam <i>Spatula electrode, flexible</i> <i>Electrodo de espátula, flexible</i> | 5 |  | Umax: 2 KVp |

Microdissektions-Nadelelektroden, wiederverwendbar, 4 mm, autoklavierbar 134°C

Mircodissection Needle Electrodes, reusable, 4 mm, autoclavable 134°C

Electrodos de aguja de micro disección reusables, 4 mm, con autoclave en 134 °C

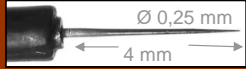
| Art. Nr. Art. No. Art. N° | Beschreibung Description Descripción |  |
|---------------------------------|--|---|
|---------------------------------|--|---|

| | | |
|----------|--|-----------------------------|
| ST-286-1 | Microdissektions-Nadelelektrode, biegsam, Wolfram 0,25 mm x 4 mm <i>Microdissection Needle Electrode, flexible, Tungsten 0,25 mm x 4 mm</i> <i>Electr. de aguja de microdisección, flexible, tungsteno 0,25 mm x 4mm</i> | VPE 1 Unit 1 unidad 1 |
|----------|--|-----------------------------|



| | | |
|----------|---|-----------------------------|
| ST-286-2 | Microdissektions-Nadelelektrode, biegsam, 45°, Wolfram 0,25 mm x 4 mm <i>Microdissection Needle Electrode, flexible, 45°, Tungsten 0,25 mm x 4 mm</i> <i>Electr. aguja de microdisección, flexible, 45°, tungsteno 0,25 mm x 4 mm</i> | VPE 1 Unit 1 unidad 1 |
|----------|---|-----------------------------|



| | | |
|----------|---|-----------------------------|
| ST-286-3 | Microdissektions-Nadelelektrode, biegsam, Wolfram 0,25 mm x 4 mm <i>Microdissection Needle Electrode, flexible, Tungsten 0,25 mm x 4 mm</i> <i>Electr. de aguja de microdisección, flexible, tungsteno 0,25 mm x 4 mm</i> | VPE 1 Unit 1 unidad 1 |
|----------|---|-----------------------------|



| | | |
|----------|---|-----------------------------|
| ST-286-4 | Microdissektions-Nadelelektrode, biegsam, 45°, Wolfram 0,25 mm x 4 mm <i>Microdissection Needle Electrode, flexible, 45°, Tungsten 0,25 mm x 4 mm</i> <i>Electr. de aguja de microdisección, flexible 45°, tungsteno 0,25 mm x 4 mm</i> | VPE 1 Unit 1 unidad 1 |
|----------|---|-----------------------------|



| | | |
|----------|--|-----------------------------|
| ST-286-5 | Microdissektions-Nadelelektrode, biegsam, Wolfram 0,25 mm x 4 mm <i>Microdissection Needle Electrode, flexible, Tungsten 0,25 mm x 4 mm</i> <i>Electrodo de aguja de microdisección, flexible, tungsteno 0,25 mm x 4mm</i> | VPE 1 Unit 1 unidad 1 |
|----------|--|-----------------------------|



| | | |
|----------|--|-----------------------------|
| ST-286-6 | Microdissektions-Nadelelektrode, biegsam, 45°, Wolfram 0,25 mm x 4 mm <i>Microdissection Needle Electrode, flexible, 45°, Tungsten 0,25 mm x 4 mm</i> <i>Electr. de aguja de microdisección, flexible, 45°, tungsteno 0,25 mm x 4 mm</i> | VPE 1 Unit 1 unidad 1 |
|----------|--|-----------------------------|

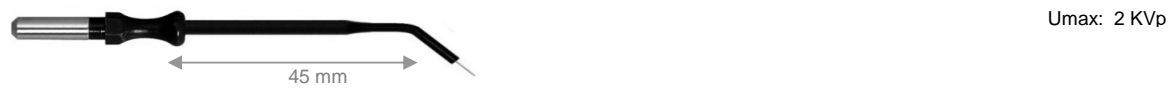

| | | |
|----------|---|-----------------------------|
| ST-290-0 | Microdissektions-Nadelelektrode, biegsam, Wolfram 0,25 mm x 4 mm <i>Microdissection Needle Electrode, Tungsten 0,25 mm x 4 mm</i> <i>Electrodo de aguja de microdisección, tungsteno 0,25 mm x 4 mm</i> | VPE 5 Unit 5 unidad 5 |
|----------|---|-----------------------------|



| | | |
|----------|---|-----------------------------|
| ST-290-5 | Microdissektions-Nadelelektrode, biegsam, 45°, Wolfram 0,25 mm x 4 mm <i>Microdissection Needle Electrode, flexible, 45°, Tungsten 0,25 mm x 4 mm</i> <i>Electr. de aguja de microdisección flexible, 45°, tungsteno 0,25 mm x 4 mm</i> | VPE 5 Unit 5 unidad 5 |
|----------|---|-----------------------------|

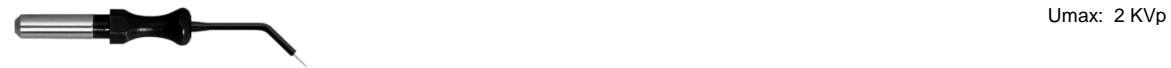

Microdissektions-Nadelelektroden, wiederverwendbar, 2,4 mm, autoklavierbar 134°C

Mircodissection Needle Electrodes, reusable, 2,4 mm, autoclavable 134°C

Electrodos de aguja de microdissección, reusables, 2,4 mm, con autoclave en 134° C

| Art. Nr. Art. No. Art. N° | Beschreibung Description Descripción |  |
|---------------------------------|--|---|
|---------------------------------|--|---|

| | | |
|----------|---|-----------------------------|
| ST-386-1 | Microdissektions-Nadelelektrode, biegsam, Wolfram 0,25 mm x 4 mm <i>Microdissection Needle Electrode, flexible, Tungsten 0,25 mm x 4 mm</i> Electr. de aguja de microdissección, flexible, tungsteno 0,25 mm x 4 mm | VPE 1 Unit 1 unidad 1 |
|----------|---|-----------------------------|



| | | |
|----------|--|-----------------------------|
| ST-386-2 | Microdissektions-Nadelelektrode, biegsam, 45°, Wolfram 0,25 mm x 4 mm <i>Microdissection Needle Electrode, flexible, 45°, Tungsten 0,25 mm x 4 mm</i> Electr. de aguja de microdissección, flexible, 45°, tungsteno 0,25 mm x 4 mm | VPE 1 Unit 1 unidad 1 |
|----------|--|-----------------------------|

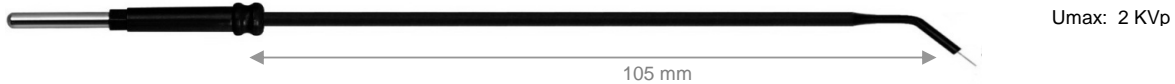

| | | |
|----------|---|-----------------------------|
| ST-386-3 | Microdissektions-Nadelelektrode, biegsam, Wolfram 0,25 mm x 4 mm <i>Microdissection Needle Electrode, flexible, Tungsten 0,25 mm x 4 mm</i> Electr. de aguja de microdissección, flexible, tungsteno 0,25 mm x 4 mm | VPE 1 Unit 1 unidad 1 |
|----------|---|-----------------------------|



| | | |
|----------|---|-----------------------------|
| ST-386-4 | Microdissektions-Nadelelektrode, biegsam, 45°, Wolfram 0,25 mm x 4 mm <i>Microdissection Needle Electrode, flexible, 45°, Tungsten 0,25 mm x 4 mm</i> Electr. de aguja de microdissección, flexible, 45°, tungsteno, 0,25 mm x 4 mm | VPE 1 Unit 1 unidad 1 |
|----------|---|-----------------------------|



| | | |
|----------|---|-----------------------------|
| ST-386-7 | Microdissektions-Nadelelektrode, biegsam, Wolfram 0,25 mm x 4 mm <i>Microdissection Needle Electrode, flexible, Tungsten 0,25 mm x 4 mm</i> Electr. de aguja de microdissección, flexible, tungsteno 0,25 mm x 4 mm | VPE 1 Unit 1 unidad 1 |
|----------|---|-----------------------------|



| | | |
|----------|--|-----------------------------|
| ST-386-8 | Microdissektions-Nadelelektrode, biegsam, 45°, Wolfram 0,25 mm x 4 mm <i>Microdissection Needle Electrode, flexible, 45°, Tungsten 0,25 mm x 4 mm</i> Electr. de aguja de microdissección, flexible, 45°, tungsteno 0,25 mm x 4 mm | VPE 1 Unit 1 unidad 1 |
|----------|--|-----------------------------|



| | | |
|----------|--|-----------------------------|
| ST-390-0 | Microdissektions-Nadelelektrode, Wolfram 0,25 mm x 4 mm <i>Microdissection Needle Electrode, Tungsten 0,25 mm x 4 mm</i> Electr. de aguja de microdissección, tungsteno 0,25 mm x 4 mm | VPE 5 Unit 5 unidad 5 |
|----------|--|-----------------------------|



| | | |
|----------|--|-----------------------------|
| ST-390-5 | Microdissektions-Nadelelektrode, biegsam, 45°, Wolfram 0,25 mm x 4 mm <i>Microdissection Needle Electrode, flexible, 45°, Tungsten 0,25 mm x 4 mm</i> Electr. de aguja de microdissección, flexible, 45°, tungsteno 0,25 mm x 4 mm | VPE 5 Unit 5 unidad 5 |
|----------|--|-----------------------------|



Nadelelektroden mit Keramikisolation, wiederverwendbar, 4 mm, autoklavierbar 134°C

Needle electrodes with ceramic, reusable, 4 mm, autoclavable 134°C

Electrodos de aguja con cerámica, reusable, 4mm, con autoclave en 134° C

| Art. Nr. Art. No. Art. N° | Beschreibung Description Descripción | |
|---------------------------------|--|--|
|---------------------------------|--|--|

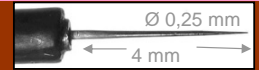

| | | |
|----------|--|--|
| ST-287-1 | <p>Wolfram-Nadelelektrode, mit Keramikisolation, 0,5 x 4 mm, gebogen, 115 mm <i>Tungsten needle electrode, with ceramic, 0,5 x 4 mm, angular, 115 mm</i> <i>Electrodo de aguja de tungsteno, con cerámica, 0,5 x 4 mm, angular, 115 mm</i></p> | <p>VPE 1 Unit 1 unidad 1</p> |
|----------|--|--|



| | | |
|----------|---|--|
| ST-287-2 | <p>Wolfram-Nadelelektrode, mit Keramikisolation, 0,5 x 4 mm, 115 mm <i>Tungsten needle electrode, with ceramic, 0,5 x 4 mm, 115 mm</i> <i>Electrodo de aguja de tungsteno, con cerámica, 0,5 x 4 mm, 115 mm</i></p> | <p>VPE 1 Unit 1 unidad 1</p> |
|----------|---|--|



| | | |
|----------|---|--|
| ST-287-3 | <p>Wolfram-Nadelelektrode, mit Keramikisolation, 0,5 x 4 mm, abgewinkelt, 80 mm <i>Tungsten needle electrode, with ceramic, 0,5 x 4 mm, angular, 80 mm</i> <i>Electr. de aguja de tungsteno, con cerámica, 0,5 x 4 mm, angular, 80 mm</i></p> | <p>VPE 1 Unit 1 unidad 1</p> |
|----------|---|--|



| | | |
|----------|---|--|
| ST-287-4 | <p>Wolfram-Nadelelektrode, mit Keramikisolation, 0,5 x 4 mm <i>Tungsten needle electrode, with ceramic, 0,5 x 4 mm</i> <i>Electrodo de aguja de tungsteno, con cerámica, 0,5 x 4 mm</i></p> | <p>VPE 1 Unit 1 unidad 1</p> |
|----------|---|--|



| | | |
|----------|--|--|
| ST-287-5 | <p>Wolfram-Nadelelektrode, mit Keramikisolation, 0,5 x 4 mm, abgewinkelt, 45 mm <i>Tungsten needle electrode, with ceramic, 0,5 x 4 mm, angular, 45 mm</i> <i>Electr. de aguja de tungsteno con cerámica, 0,5 x 4 mm, angular, 45 mm</i></p> | <p>VPE 1 Unit 1 unidad 1</p> |
|----------|--|--|

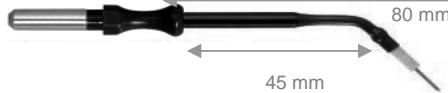

| | | |
|----------|--|--|
| ST-287-6 | <p>Wolfram-Nadelelektrode, mit Keramikisolation, 0,5 x 4 mm <i>Tungsten needle electrode, with ceramic, 0,5 x 4 mm</i> <i>Electrodo de aguja de tungsteno, con cerámica, 0,5 x 4mm</i></p> | <p>VPE 1 Unit 1 unidad 1</p> |
|----------|--|--|



| | | |
|----------|---|--|
| ST-287-7 | <p>Wolfram-Nadelelektrode, mit Keramikisolation, 0,5 x 4 mm, abgewinkelt, 20 mm <i>Tungsten needle electrode, with ceramic, 0,5 x 4 mm, angular, 20 mm</i> <i>Electrodo de aguja de tungsteno, con cerámica, 0,5 x 4 mm, angular, 20 mm</i></p> | <p>VPE 1 Unit 1 unidad 1</p> |
|----------|---|--|

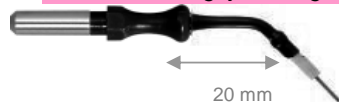

| | | |
|----------|--|--|
| ST-287-8 | <p>Wolfram-Nadelelektrode, mit Keramikisolation, 0,5 x 4 mm <i>Tungsten needle electrode, with ceramic, 0,5 x 4 mm</i> <i>Electrodo de aguja de tungsteno con cerámica, 0,5 x 4 mm</i></p> | <p>VPE 1 Unit 1 unidad 1</p> |
|----------|--|--|



Nadelelektroden mit Keramikisolation, wiederverwendbar, 2,4 mm, autoklavierbar 134°C

Needle electrodes with ceramic, reusable, 2,4 mm, autoclavable 134°C

Electrodos de aguja con cerámica, reusables, 2,4 mm, con autoclave en 134° C

| Art. Nr. Art. No. Art. N° | Beschreibung Description Descripción | |
|---------------------------------|--|--|
|---------------------------------|--|--|

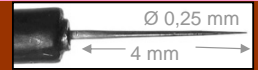

| | | |
|----------|---|--|
| ST-387-1 | <p>Wolfram-Nadelelektrode, mit Keramikisolation, 0,5 x 4 mm, abgewinkelt, 105 mm <i>Tungsten needle electrode, with ceramic, 0,5 x 4 mm, angular, 105 mm</i> Electrodo de aguja de tungsteno con cerámica, 0,5 x 4mm, angular, 105 mm</p> | <p>VPE 1 Unit 1 unidad 1</p> |
|----------|---|--|



| | | |
|----------|--|--|
| ST-387-2 | <p>Wolfram-Nadelelektrode, mit Keramikisolation, 0,5 x 4 mm <i>Tungsten needle electrode, with ceramic, 0,5 x 4 mm</i> Electrodo de aguja de tungsteno, con cerámica, 0,5 x 4 mm</p> | <p>VPE 1 Unit 1 unidad 1</p> |
|----------|--|--|



| | | |
|----------|---|--|
| ST-387-3 | <p>Wolfram-Nadelelektrode, mit Keramikisolation, 0,5 x 4 mm, abgewinkelt, 70 mm <i>Tungsten needle electrode, with ceramic, 0,5 x 4 mm, angled, 70 mm</i> Electrodo de aguja de tungsteno, con cerámica, 0,5 x 4 mm, angular, 70 mm</p> | <p>VPE 1 Unit 1 unidad 1</p> |
|----------|---|--|



| | | |
|----------|--|--|
| ST-387-4 | <p>Wolfram-Nadelelektrode, mit Keramikisolation, 0,5 x 4 mm <i>Tungsten needle electrode, with ceramic, 0,5 x 4 mm</i> Electrodo de aguja de tungsteno, con ceramica, 0,5 x 4 mm</p> | <p>VPE 1 Unit 1 unidad 1</p> |
|----------|--|--|



| | | |
|----------|---|--|
| ST-387-5 | <p>Wolfram-Nadelelektrode, mit Keramikisolation, 0,5 x 4 mm, abgewinkelt, 35 mm <i>Tungsten needle electrode, with ceramic, 0,5 x 4 mm, angular, 35 mm</i> Electrodo de aguja de tungsteno con cerámica, 0,5 x 4 mm, angular, 35 mm</p> | <p>VPE 1 Unit 1 unidad 1</p> |
|----------|---|--|



| | | |
|----------|---|--|
| ST-387-6 | <p>Wolfram-Nadelelektrode, mit Keramikisolation, 0,5 x 4 mm <i>Tungsten needle electrode, with ceramic, 0,5 x 4 mm</i> Electrodo de aguja de tungsteno, con cerámica, 0,5 x 4mm</p> | <p>VPE 1 Unit 1 unidad 1</p> |
|----------|---|--|



| | | |
|----------|---|--|
| ST-387-7 | <p>Wolfram-Nadelelektrode, mit Keramikisolation, 0,5 x 4 mm, abgewinkelt, 20 mm <i>Tungsten needle electrode, with ceramic, 0,5 x 4 mm, angular, 20 mm</i> Electrodo de aguja de tungsteno, con cerámica, 0,5 x 4mm, angular, 20 mm</p> | <p>VPE 1 Unit 1 unidad 1</p> |
|----------|---|--|



| | | |
|----------|--|--|
| ST-387-8 | <p>Wolfram-Nadelelektrode, mit Keramikisolation, 0,5 x 4 mm <i>Tungsten needle electrode, with ceramic, 0,5 x 4 mm</i> Electrodo de aguja de tungsteno, con ceramica, 0,5 x 4 mm</p> | <p>VPE 1 Unit 1 unidad 1</p> |
|----------|--|--|



Arthroskopieelektroden, wiederverwendbar, 4 mm, autoklavierbar 134°C

Arthroscopic electrodes, reusable, 4 mm, autoclavable 134°C

Electrodos de Artroscopia, reusables, 4 mm, con autoclave en 134° C

| Art. Nr. Art. No. Art. N° | Beschreibung Description Descripción |
|---------------------------------|--|
|---------------------------------|--|



Umax: 4 KVP

| | | |
|----------|---|-----------------------------|
| ST-802-1 | Nadelelektrode, 90° abgewinkelt, 1,5 mm, Schaftlänge 115 mm, Ø 0,6 mm Needle electrode, 90° angled, 1,5 mm, shaft length 115 mm, Ø 0,6 mm Electrodo de aguja, 90° angular, 1,5 mm, largo del eje 115 mm, Ø 0,6 mm | VPE 1 Unit 1 unidad 1 |
|----------|---|-----------------------------|



| | | |
|----------|---|-----------------------------|
| ST-802-2 | Nadelelektrode, 90° abgewinkelt, 4 mm, Schaftlänge 115 mm, Ø 0,6 mm Needle electrode, 90° angled, 4 mm, shaft length 115 mm, Ø 0,6 mm Electrodo de aguja, 90° angular, 4 mm, largo del eje 115 mm, Ø 0,6 mm | VPE 1 Unit 1 unidad 1 |
|----------|---|-----------------------------|



| | | |
|----------|---|-----------------------------|
| ST-802-4 | Messerelektrode, 45° abgewinkelt, 4 mm, Schaftlänge 115 mm Knife electrode, 45° angled, 4 mm, shaft length 115 mm Electrodo de cuchillo, 45° angular, 4 mm, largo del eje 115mm | VPE 1 Unit 1 unidad 1 |
|----------|---|-----------------------------|



| | | |
|----------|--|-----------------------------|
| ST-802-5 | Tastelektrode, 90° abgewinkelt, 4 mm, Schaftlänge 115 mm, Ø 1,5 mm Button electrode, 90° angled, 4 mm, shaft length 115 mm, Ø 1,5 mm Electrodo de botón, 90° angular, 4 mm, largo del eje 115 mm, Ø 1,5 mm | VPE 1 Unit 1 unidad 1 |
|----------|--|-----------------------------|



| | | |
|----------|--|-----------------------------|
| ST-802-7 | Kugelelektrode, Schaftlänge 115 mm, Ø 3 mm Ball electrode, shaft length 115 mm, Ø 3 mm Electrodo de bola, largo del eje 115 mm, Ø 3 mm | VPE 1 Unit 1 unidad 1 |
|----------|--|-----------------------------|



| | | |
|----------|---|-----------------------------|
| ST-802-8 | Phazer, Hohlkugelelektrode Ø 2,4 mm, gebogen 70°, Schaftlänge 115 mm Phazer, hollow ball electrode Ø 2,4 mm, curved 70°, shaft length 115 mm Electr. de bola hueco, Phazer, Ø 2,4 mm, curvo 70°, largo del eje 115 mm | VPE 1 Unit 1 unidad 1 |
|----------|---|-----------------------------|



| | | |
|----------|---|-----------------------------|
| ST-802-9 | Phazer, Flächenelektrode Ø 2,4 mm, gebogen 70°, Schaftlänge 115 mm Phazer, flate electrode Ø 2,4 mm, curved 70°, shaft length 115 mm Electrodo plano, Phazer, Ø 2,4 mm, curvo 70°, largo del eje 115 mm | VPE 1 Unit 1 unidad 1 |
|----------|---|-----------------------------|



| | | |
|----------|---|-----------------------------|
| ST-802-6 | Phazer, Bürstenelektrode gezahnt, gebogen 70°, Schaftlänge 115 mm Phazer, brush electrode, serrated, curved 70°, shaft length 115 mm Electrodo de cepillo, Phazer, con sierras, curvo 70°, largo del eje 115 mm | VPE 1 Unit 1 unidad 1 |
|----------|---|-----------------------------|



Arthroskopieelektroden, wiederverwendbar, 2,0 mm, autoklavierbar 134°C**Arthroscopic electrodes, reusable, 2,0 mm, autoclavable 134°C****Electrodos de Artroscopía, reusables, 2,0 mm, con autoclave en 134° C**

| Art. Nr. Art. No. Art. N° | Beschreibung Description Descripción |
|---------------------------------|--|
|---------------------------------|--|



Umax: 4 KVp

| | | |
|----------|---|-----------------------------|
| ST-833-1 | Nadelelektrode, 90° abgewinkelt, 0,8 mm x 2,5 mm, Schaftlänge 110 mm Needle electrode, 90° angled, 0,8 x 2,5 mm, shaft length 110 mm Electrodo de aguja, 90° angular, 0,8 x 2,5 mm, largo del eje, 110 mm | VPE 1 Unit 1 unidad 1 |
|----------|---|-----------------------------|



| | | |
|----------|--|-----------------------------|
| ST-833-2 | Nadelelektrode, 90° abgewinkelt, 0,8 x 4 mm, Schaftlänge 110 mm Needle electrode, 90° angled, 0,8 x 4 mm, shaft length 110 mm Electrodo de aguja, 90° angular, 0,8 x 4mm, largo del eje 110 mm | VPE 1 Unit 1 unidad 1 |
|----------|--|-----------------------------|



| | | |
|----------|--|-----------------------------|
| ST-833-9 | Nadelelektrode, 90° abgewinkelt, 1,5 mm, Schaftlänge 110 mm Needle electrode, 90° angled, 1,5 mm, shaft length 110 mm Electrodo de aguja 90° angular, 1,5 mm, largo del eje 110 mm | VPE 1 Unit 1 unidad 1 |
|----------|--|-----------------------------|



| | | |
|----------|--|-----------------------------|
| ST-833-4 | Messerelektrode, 45° abgewinkelt, Schaftlänge 110 mm Knife electrode, 45° angled, shaft length 110 mm Electrodo de cuchillo, 45° angular, largo del eje 110 mm | VPE 1 Unit 1 unidad 1 |
|----------|--|-----------------------------|



| | | |
|----------|---|-----------------------------|
| ST-833-5 | Koagulationselektrode, abgewinkelt, 1,5 x 3 mm, Schaftlänge 110 mm Coagulation electrode, angled, 1,5 x 3 mm, shaft length 110 mm Electrodo de coagulación, angular, 1,5 x 3 mm, largo del eje 110 mm | VPE 1 Unit 1 unidad 1 |
|----------|---|-----------------------------|



Arthroskopieelektroden, wiederverwendbar, 2,0 mm, autoklavierbar 134°C

Arthroscopic electrodes, reusable, 2,0 mm, autoclavable 134°C

Electrodos de Artroscopía, reusables, 2,0 mm, con autoclave en 134° C

| Art. Nr. | Beschreibung | |
|----------|--------------|--|
| Art. No. | Description | |
| Art. N° | Descripción | |

Umax: 4 KVp



| | | |
|----------|--|-----------------------------|
| ST-832-1 | Nadelelektrode, 90° abgewinkelt, 0,8 mm x 2,5 mm, Schaftlänge 170 mm Needle electrode, 90° angled, 0,8 x 2,5 mm, shaft length 170 mm Electrodo de aguja, 90° angular, 0,8 x 2,5 mm, largo del eje 170 mm | VPE 1 Unit 1 unidad 1 |
|----------|--|-----------------------------|



| | | |
|----------|--|-----------------------------|
| ST-833-6 | Messerelektrode, 45° abgewinkelt, Schaftlänge 170 mm Knife electrode, 45° angled, shaft length 170 mm Electrodo de cuchillo, 45° angular, largo del eje 170 mm | VPE 1 Unit 1 unidad 1 |
|----------|--|-----------------------------|



| | | |
|----------|--|-----------------------------|
| ST-832-5 | Koagulationselektrode, abgewinkelt, 1,5 x 3 mm, Schaftlänge 170 mm Coagulation electrode, angled, 1,5 x 3 mm, shaft length 170 mm Electrodo de coagulación, angular 1,5 x 3 mm, largo del eje 170 mm | VPE 1 Unit 1 unidad 1 |
|----------|--|-----------------------------|



Arthroskopieelektroden, wiederverwendbar, 2,4 mm, autoklavierbar 134°C

Arthroscopic electrodes, reusable, 2,4 mm, autoclavable 134°C

Electrodos de artroscopía, reusables, 2,4 mm, con autoclave en 134°C

| Art. Nr. Art. No. Art. N° | Beschreibung Description Descripción |
|---------------------------------|--|
|---------------------------------|--|

Umax: 4 KVp



| | | |
|----------|---|-----------------------------|
| ST-805-1 | Nadelelektrode, 90° abgewinkelt, 1,5 mm, Schaftlänge 115 mm, Ø 0,6 mm Needle electrode, 90° angled, 1,5 mm, shaft length 115 mm, Ø 0,6 mm Electrodo de aguja, 90° angular, 1,5 mm, largo del eje 115 mm, Ø 0,6 mm | VPE 1 Unit 1 unidad 1 |
|----------|---|-----------------------------|



| | | |
|----------|---|-----------------------------|
| ST-805-2 | Nadelelektrode, 90° abgewinkelt, 4 mm, Schaftlänge 115 mm, Ø 0,6 mm Needle electrode, 90° angled, 4 mm, shaft length 115 mm, Ø 0,6 mm Electrodo de Aguja, 90° angular, 4 mm, largo del eje 115 mm, Ø 0,6 mm | VPE 1 Unit 1 unidad 1 |
|----------|---|-----------------------------|



| | | |
|----------|--|-----------------------------|
| ST-805-4 | Messerelektrode, 45° abgewinkelt, 4 mm, Schaftlänge 115 mm Knife electrode, 45° angled, 4 mm, shaft length 115 mm Electrodo de cuchillo, 45° angular, 4 mm, largo del eje 115 mm | VPE 1 Unit 1 unidad 1 |
|----------|--|-----------------------------|



| | | |
|----------|--|-----------------------------|
| ST-805-5 | Tastelektrode, 90° abgewinkelt, 4 mm, Schaftlänge 115 mm, Ø 1,5 mm Button electrode, 90° angled, 4 mm, shaft length 115 mm, Ø 1,5 mm Electrodo de boton, 90° angular, 4 mm, largo del eje 115 mm, Ø 1,5 mm | VPE 1 Unit 1 unidad 1 |
|----------|--|-----------------------------|



| | | |
|----------|--|-----------------------------|
| ST-805-7 | Kugelelektrode, Schaftlänge 115 mm, Ø 3 mm Ball electrode, shaft length 115 mm, Ø 3 mm Electrodo de bola, largo del eje 115 mm, Ø 3 mm | VPE 1 Unit 1 unidad 1 |
|----------|--|-----------------------------|



| | | |
|----------|--|-----------------------------|
| ST-805-8 | Phazer, Hohlkugelelektrode Ø 2,4 mm, gebogen 70°, Schaftlänge 115 mm Phazer, hollow ball electrode Ø 2,4 mm, curved 70°, shaft length 115 mm Electr. de bola hueco, Phazer, Ø 2,4 mm curvo 70°, largo del eje 115 mm | VPE 1 Unit 1 unidad 1 |
|----------|--|-----------------------------|



| | | |
|----------|---|-----------------------------|
| ST-805-9 | Phazer, Flächenelektrode Ø 2,4 mm, gebogen 70°, Schaftlänge 115 mm Phazer, flate electrode Ø 2,4 mm, curved 70°, shaft length 115 mm Electrodo plano, Phazer, Ø 2,4 mm, curvo 70°, largo del eje 115 mm | VPE 1 Unit 1 unidad 1 |
|----------|---|-----------------------------|



| | | |
|----------|--|-----------------------------|
| ST-805-6 | Phazer, Bürstenelektrode gezahnt, gebogen 70°, Schaftlänge 115 mm Phazer, brush electrode, serrated, curved 70°, shaft length 115 mm, Electrodo de cepillo, Phazer, con sierras, curvo 70°, largo del eje 115 mm | VPE 1 Unit 1 unidad 1 |
|----------|--|-----------------------------|



Arthroskopieelektroden, mit Handgriff, wiederverwendbar, 4 mm, autoklavierbar 134°C Umax: 4 KVp

Arthroscopic electrodes, with handle, reusable, 4 mm, autoclavable 134°C

Electrodos de artroscopía, con mango, reusables, 4 mm, con autoclave en 134° C

| Art. Nr. Art. No. Art. N° | Beschreibung Description Descripción | |
|---------------------------------|--|--|
|---------------------------------|--|--|

| | | |
|----------|--|-----------------------------|
| ST-800-1 | Nadelelektrode, 115 x 1,5 x Ø 0,6 mm; 90° abgewinkelt, mit Handgriff <i>Needle electrode, 115 x 1,5 x Ø 0,6 mm; 90° angular, with handle</i> <i>Electrodo de aguja, 115 x 1,5 x Ø 0,6 mm; 90° angular, con mango</i> | VPE 1 Unit 1 unidad 1 |
|----------|--|-----------------------------|



Umax: 2 KVp

| | | |
|----------|--|-----------------------------|
| ST-800-2 | Nadelelektrode, 115 x 4 x Ø 0,6 mm; 90° abgewinkelt, mit Handgriff <i>Needle electrode, 115 x 4 x Ø 0,6 mm; 90° angular, with handle</i> <i>Electrodo de aguja, 115 x 4 x Ø 0,6 mm; 90° angular, con mango</i> | VPE 1 Unit 1 unidad 1 |
|----------|--|-----------------------------|



Umax: 2 KVp

| | | |
|----------|--|-----------------------------|
| ST-800-4 | Messerelektrode, 45° abgewinkelt, 4 mm, Schaftlänge 115 mm <i>Knife electrode, 45° angled, 4 mm, shaft length 115 mm</i> <i>Electrodo de cuchillo, 45° angular, 4 mm, largo del eje 115 mm</i> | VPE 1 Unit 1 unidad 1 |
|----------|--|-----------------------------|



Umax: 2 KVp

| | | |
|----------|--|-----------------------------|
| ST-800-5 | Tastelektrode mit Handgriff, 90° abgewinkelt, 4 mm, Länge 115 mm, Ø 1,5 mm <i>Button electrode with handle, 90° angled, 4 mm, length 115 mm, Ø 1,5 mm</i> <i>Electr. de boton con mango, angular a 90°, 4 mm, largo 115 mm, Ø 1,5 mm</i> | VPE 1 Unit 1 unidad 1 |
|----------|--|-----------------------------|







Umax: 2 KVp

| | | |
|----------|---|-----------------------------|
| ST-800-7 | Kugelelektrode, 115 x Ø 3 mm, mit Handgriff <i>Ball electrode, 115 x Ø 3 mm, with handle</i> <i>Electrodo de bola, 115x Ø 3 mm, con mango</i> | VPE 1 Unit 1 unidad 1 |
|----------|---|-----------------------------|



Umax: 2 KVp

Arthroskopieelektroden, mit Handgriff, wiederverwendbar, 4 mm, autoklavierbar 134°C**Arthroscopic electrodes, with handle, reusable, 4 mm, autoclavable 134°C****Electrodos de artroscopía, con mango, reusables, 4mm, con autoclave en 134°C**

| Art. Nr. Art. No. Art. N° | Beschreibung Description Descripción | | |
|---------------------------------|---|-----------------------------|-------------|
| ST-801-1 | Nadelelektrode, 170 x 1,5 x Ø 0,6 mm; 90° abgewinkelt, mit Handgriff Needle electrode, 170 x 1,5 x Ø 0,6 mm; 90° angular, with handle Electrodo de aguja, 170 x 1,5 x Ø 0,6 mm, angular a 90°, con mango | VPE 1 Unit 1 unidad 1 | Umax: 2 KVp |
| |  | | |
| ST-801-2 | Nadelelektrode; 170 x 4 x Ø 0,6 mm; 90° abgewinkelt; mit Handgriff Needle electrode, 170 x 4 x Ø 0,6 mm; 90° angular, with handle Electrodo de aguja, 170 x 4 x Ø 0,6 mm, angular a 90°, con mango | VPE 1 Unit 1 unidad 1 | Umax: 2 KVp |
| |  | | |
| ST-801-3 | Messerelektrode, 45° abgewinkelt, 4 mm, Schaftlänge 170 mm Knife electrode, 45° angled, 4 mm, shaft length 170 mm Electrodo de cuchillo, angular a 45°, 4 mm, largo del eje 170 mm | VPE 1 Unit 1 unidad 1 | Umax: 2 KVp |
| |  | | |
| ST-801-4 | Tastelektrode mit Handgriff, 90° abgewinkelt, 4 mm, Länge 170 mm, Ø 1,5 mm Button electrode with handle, 90° angled, 4 mm, length 170 mm, Ø 1,5 mm Electr. de botón, con mango, angular a 90°, 4 mm, largo 170 mm, Ø 1,5 mm | VPE 1 Unit 1 unidad 1 | Umax: 2 KVp |
| |  | | |
| ST-801-7 | Kugelelektrode, 170 x Ø 3 mm, mit Handgriff Ball electrode, 170 x Ø 3 mm, with handle Electrodo de bola, 170 x Ø 3 mm con mango | VPE 1 Unit 1 unidad 1 | Umax: 2 KVp |
| |  | | |

Bipolare Arthroskopieelektroden, wiederverwendbar, autoklavierbar 134°C

Bipolar arthroscopic electrodes, reusable, autoclavable 134°C

Electrodos para Artroscopía bipolares, reusables, con autoclave en 134° C

| Art. Nr. | Beschreibung | |
|----------|--------------|--|
| Art. No. | Description | |
| Art. N° | Descripción | |

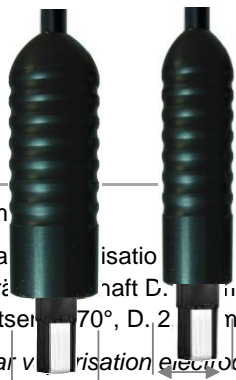

| | | |
|----------|---|-------------|
| ST-879-0 | <p>170 mm</p> <p>Bipolare Vaporisations-Elektrode "Phazer" versträrkter Schaft D. 5 mm Arbeitsende 70°, D. 2,4 mm</p> <p><i>bipolar vaporisation electrode "Phazer" strengthened shaft d. 5 mm working end 70°, d. 2,4 mm</i></p> <p><i>Electrodo vaporizador bipolar "Phazer" eje fortalecido diámetro 5 mm punta de trabajo en 70°, diámetro 2,4 mm</i></p> | Umax: 2 KVp |
| ST-879-1 | <p>115 mm</p> | |
| ST-879-5 | <p>170 mm</p> <p>Bipolare Vaporisations-Elektrode "Phazer" versträrkter Schaft D. 5 mm Arbeitsende 90°, D. 2,4 mm</p> <p><i>bipolar vaporisation electrode "Phazer" strengthened shaft d. 5 mm working end 90°, d. 2,4 mm</i></p> <p><i>Electrodo vaporizador bipolar "Phazer" eje fortalecido diámetro 5 mm punta de trabajo en 90°, diámetro 2,4 mm</i></p> | Umax: 2 KVp |
| ST-879-9 | <p>115 mm</p> | |



Bipolare Arthroskopieelektroden, wiederverwendbar, autoklavierbar 134°C

Bipolar arthroscopic electrodes, reusable, autoclavable 134°C

Electrodos de artroscopía bipolares, reusables, con autoclave en 134°C

| Art. Nr. | Beschreibung | |
|----------|--------------|--|
| Art. No. | Description | |
| Art. N° | Descripción | |



| | | |
|----------|---|---|
| ST-870-3 | <p>170 mm</p> <p>Bipolare Schneidelektrode "Hook"</p> <p>Schaft 4,0 mm</p> <p>Arbeitsende 1,5 x 0,6 mm</p> <p><i>bipolar cutting electrode "Hook"</i></p> <p><i>shaft d. 4,0 mm</i></p> <p><i>working end 1,5 x 0,6 mm</i></p> <p><i>Electrodo cortador bipolar "Hook"</i></p> <p><i>eje con diámetro 4,0 mm</i></p> <p><i>punta de trabajo de 1,5 x 0,6 mm</i></p> | <p>Umax: 2 KVp</p>  |
| ST-870-1 | <p>115 mm</p> | |
| ST-870-6 | <p>170 mm</p> <p>Bipolare Schneidelektrode "Hook"</p> <p>Schaft D. 4,0 mm</p> <p>Arbeitsende 4,0 x 0,6 mm</p> <p><i>bipolar cutting electrode "Hook"</i></p> <p><i>shaft d. 4,0 mm</i></p> <p><i>working end 4,0 x 0,6 mm</i></p> <p><i>Electrodo cortador bipolar "Hook"</i></p> <p><i>eje con diámetro 4,0 mm</i></p> <p><i>punta de trabajo 4,0 x 0,6 mm</i></p> | <p>Umax: 2 KVp</p>  |
| ST-870-2 | <p>115 mm</p> | |

Bipolare HNO Elektroden, wiederverwendbar, autoklavierbar 134°C

Bipolar ENT electrodes, reusable, autoclavable 134°C

Electrodos ENT bipolares, reusables, con autoclave en 134°C

| Art. Nr. | Beschreibung |
|----------|--------------|
| Art. No. | Description |
| Art. N° | Descripción |

Griff
handle
Mango



ST-98002

Bipolarelektrode HNO vertikal, Nadel vertikal, Biegung 16,5 mm vom Griff

bipolar ENT electrode vertical, needle vertical, bent 16,5 mm from handle

Electrodo ENT vertical bipolar, aguja vertical, con curvatura de 16,5 mm del mango

Spitze
tip
Punta



Umax: 2 KVp

ST-98003

Bipolarelektrode HNO horizontal, Nadel horizontal, Biegung 94 mm vom Griff

bipolar ENT electrode horizontal, needle horizontal, bent 94 mm from handle

Electrodo ENT bipolar horizontal, con aguja horizontal, con curvatura de 94 mm del mango

Spitze
tip
Punta



Umax: 2 KVp

ST-98005

Bipolare Turbinotomie-Elektrode (Doppelnadel), horizontal, 50 mm vom Griff abgewinkelt, 25°
35 mm Doppelnadel, Spitze 10 mm isoliert, 25 mm unisoliert

*bipolar electrode for turbinotomie (double needle), horizontal, angled 50 mm from handle, 25°
35 mm double needle, tip 10 mm insulated, 25 mm not insulated*

*Electrodo bipolar para Turbinectomía (con doble aguja), horizontal, anguar a 50 mm del mango, 25°
35 mm de doble aguja, punta aislada de 10 mm, 25 mm no aislada*

Spitze
tip
Punta



Umax: 2 KVp

Laparoskopieelektroden mit Keramik, wiederverwendbar, autoklavierbar 134°C

Laparoscopic electrodes with ceramic, reusable, autoclavable 134°C

Electrodos para laparoscopia con cerámica, reusables, con autoclave en 134°C

| Art. Nr. Art. No. Art. N° | Beschreibung Description Descripción | VPE Unit unid. |
|---------------------------------|--|----------------------|
|---------------------------------|--|----------------------|

Elektroden mit Keramik, vollisoliert, Elekt. Anschluss: 4 mm Stecker

Electrodes with ceramic, fully insulated, Elect. Connector: 4 mm plug

Electrodos con cerámica, totalmente aislados, con conector eléctrico: enchufe de 4 mm



| | | | | |
|----------|--|---|--|-------------|
| ST-709-5 | <p>Hakenelektrode Handgriff 60 mm, Durchmesser 16 mm</p> <p><i>Hook Electrode handle 60 mm, diameter 16 mm</i></p> <p><i>Electrodo de gancho mango de 60 mm, diámetro de 16 mm</i></p> | 1 | | Umax: 4 KVp |
| ST-709-3 | <p>Spatelelektrode Handgriff 60 mm, Durchmesser 16 mm</p> <p><i>Spatula Electrode handle 60 mm, diameter 16 mm</i></p> <p><i>Electrodo de espátula con mango de 60 mm, diámetro de 16 mm</i></p> | 1 | | Umax: 4 KVp |
| ST-710-5 | <p>Hakenelektrode Handgriff 50 mm, Durchmesser 13 mm</p> <p><i>Hook Electrode handle 50 mm, diameter 13 mm</i></p> <p><i>Electrodo de gancho con mango de 50 mm, diámetro de 13 mm</i></p> | 1 | | Umax: 4 KVp |
| ST-710-3 | <p>Spatelelektrode Handgriff 50 mm, Durchmesser 13 mm</p> <p><i>Spatula Electrode handle 50 mm, diameter 13 mm</i></p> <p><i>Electrodo de espátula con mango de 50 mm, diámetro de 13 mm</i></p> | 1 | | Umax: 4 KVp |

Laparoskopieelektroden mit Absaugung, wiederverwendbar, autoklavierbar 134°C
Laparoscopic electrodes with suction, reusable, autoclavable 134°C
Electrodos para laparoscopia, con succión, reusables, con autoclave a 134° C

| Art. Nr. | Beschreibung | VPE | |
|----------|--------------|-------|--|
| Art. No. | Description | Unit | |
| Art. N° | Descripción | unid. | |

Elektroden mit Keramik, vollisoliert, mit Absaugung, Elekt. Anschluss: 4 mm Stecker
 Electrodes with ceramic, fully insulated, with suction, Elect. Connector: 4 mm plug
 Electrodos con cerámica, totalmente aislados, con succión con conector eléctrico: 4 mm de enchufe









| | | | | |
|----------|---|---|--|-------------|
| ST-715-3 | <p>Spatелеlektrode Handgriff 60 mm, Durchmesser 16 mm <i>spatula electrode handle 60 mm, diameter 16 mm</i> Electrodo de espátula mango de 60 mm, diámetro de 16 mm</p> | 1 |  | Umax: 4 KVp |
| ST-715-4 | <p>L-Haken-Elektrode Handgriff 60 mm, Durchmesser 16 mm <i>L-hook-electrode handle 60 mm, diameter 16 mm</i> Electrodo de gancho en "L" mango de 60 mm, diámetro 16 mm</p> | 1 |  | Umax: 4 KVp |
| ST-715-5 | <p>J-Haken-Elektrode Handgriff 60 mm, Durchmesser 16 mm <i>J-hook-electrode handle 60 mm, diameter 16 mm</i> Electrodo de gancho en "J" mango 60 mm, diámetro 16 mm</p> | 1 |  | Umax: 4 KVp |

HF-Handgriffe, wiederverwendbar, autoklavierbar 134 °C

HF-handpiece, reusable, autoclavable 134°C

Pieza de mano, HF, reusable, con autoclave en 134 °C

| Art. Nr. Art. No. Art. N° | Beschreibung Description Descripción | VPE Unit unid. | |
|---------------------------------|---|----------------------|--|
| ST-92047 | HF Handgriff für 4 mm Schaft - Elektroden <i>HF handpiece for 4 mm shaft-electrodes</i> <i>Pieza de mano HF para eje de electrodos de 4 mm</i> | 1 | <p>Erbe ACC/ICC</p>  |
| ST-92048 | Handgriff für 2,4 mm Schaft - Elektroden <i>HF handpiece for 2,4 mm shaft-electrodes</i> <i>Pieza de mano para eje de electrodos de 2,4 mm</i> | | |
| ST-92071 | 4 m HF Handgriff - Kabel Erbe kompatibel <i>HF handpiece - cable Erbe compatible</i> <i>Pieza de mano HF- compat. c. cable Erbe</i> | 1 | <p>HF-Gerät ERBE ACC/ICC</p>  <p>HF-Unit ERBE ACC/ICC HF-Unidad ERBE ACC/ICC</p> |
| ST-92070 | 5 m HF Handgriff - Kabel Erbe kompatibel <i>HF handpiece - cable Erbe compatible</i> <i>Pieza de mano HF- compat. c. cable Erbe</i> | | |
| ST-92045 | HF Handgriff für 4 mm Schaft - Elektroden <i>HF handpiece for 4 mm shaft - electrodes</i> <i>Pieza de mano HF p. eje de electr. de 4 mm</i> | 1 | <p>Erbe T-Serie</p>  |
| ST-92072 | 5 m HF Handgriff - Kabel Erbe kompatibel <i>HF handpiece - cable Erbe compatible</i> <i>Pienza d. mano HF- compat. con cable Erbe</i> | 1 | <p>HF-Gerät/Unit ERBE T-Serie/Series Unidad HF ERBE Serie-T</p>  |
| ST-92043 | HF Handgriff für 4 mm Schaft - Elektroden <i>HF handpiece for 4 mm shaft - electrodes</i> <i>Pieza de mano HF p. eje de electr. de 4 mm</i> | 1 | <p>Martin / Berchtold</p>  |
| ST-92044 | Handgriff für 2,4 mm Schaft - Elektroden <i>HF handpiece for 2,4 mm shaft-electrodes</i> <i>Pieza de mano HF p. eje de electr. 2,4 mm</i> | | |
| ST-92041 | 4 m HF Handgriff - Martin, Berchtold komp. <i>HF handpiece - Martin, Berchtold comp.</i> <i>Pieza de mano HF- Martin, Berchtold comp.</i> | 1 | <p>HF-Gerät Martin / Berchtold</p>  <p>HF-Unit Martin / Berchtold Unidad HF Martin/Berchtold</p> |
| ST-92040 | 5 m HF Handgriff - Martin, Berchtold komp. <i>HF handpiece - Martin, Berchtold comp.</i> <i>Pieza de mano HF- Martin, Berchtold comp.</i> | | |

HF-Handgriffe, wiederverwendbar, autoklavierbar 134 °C**HF-handpiece, reusable, autoclavable 134°C****Piezas de mano HF, reusables, con autoclave en 134° C**

| Art. Nr. Art. No. Art. N° | Beschreibung Description Descripción | VPE Unit unid. | |
|---------------------------------|---|----------------------|--|
| ST-92049 | HF Handgriff für 4 mm Schaft - Elektroden mit einer Taste <i>HF handpiece for 4 mm shaft - electrodes with one button</i> <i>Pieza manual HF para eje de electrodos de 4 mm</i> | 1 | Martin / Berchtold  |
| ST-92447 | HF Handgriff für 4 mm Schaft - Elektroden mit Spannzange <i>HF handpiece for 4 mm shaft - electrodes with chuck</i> <i>Pieza de mano para eje de electrodos de 4 mm con cortador</i> | 1 | Erbe ACC/ICC  |







Premium HF-Handgriffe mit Kabel, wiederverwendbar, autoklavierbar 134 °C

Premium HF-handpiece with integrated cable, reusable, autoclavable 134°C

Pieza manual Premium HF- con cable integrado, reusable, con autoclave en 134°C

| Artikel-Nr. Art. No. Art.N° | Beschreibung Description Descripción | Länge length Largo | Geräteseite Unit connecting Unidad de conexión |
|-----------------------------------|--|--------------------------|--|
|-----------------------------------|--|--------------------------|--|



| | | | |
|----------|---|-------|--|
| ST-92247 | <p>HF-Handgriff für 4 mm Schaftelektroden mit integriertem Kabel, mit 2 Tasten</p> <p><i>HF-handpiece for 4 mm shaft-electrodes with integrated cable, two buttons</i></p> <p><i>Pieza manual HF para eje de electr. de 4 mm con cable integrado, c. dos botones</i></p> | 5,0 m | <p>Erbe ICC/ACC, Storz</p>  |
| ST-92243 | <p>HF-Handgriff für 4 mm Schaftelektroden mit integriertem Kabel, mit 2 Tasten</p> <p><i>HF-handpiece for 4 mm shaft-electrodes with integrated cable, two buttons</i></p> <p><i>Pieza manual para eje de electr. de 4 mm con cable integrado, c. dos botones</i></p> | 5,0 m | <p>Berchtold / Integra</p>  |
| ST-92245 | <p>HF-Handgriff für 4 mm Schaftelektroden mit integriertem Kabel, mit 2 Tasten</p> <p><i>HF-handpiece for 4 mm shaft-electrodes with integrated cable, two buttons</i></p> <p><i>Pieza manual HF para eje de electr. de 4 mm con cable integrado, c. dos botones</i></p> | 5,0 m | <p>Internationale Modelle 3 pol.</p>  <p>modelo internacional 3 patas</p> |
| ST-92251 | <p>HF-Handgriff für 2,4 mm Schaftelektroden mit integriertem Kabel, mit 2 Tasten</p> <p><i>HF-handpiece for 2,4 mm shaft-electr. with integrated cable, two buttons</i></p> <p><i>Pieza manual HF para eje de electr. de 2,4 mm c. cable integrado, c. dos botones</i></p> | 5,0 m | <p>Erbe ICC/ACC, Storz</p>  |
| ST-92248 | <p>HF-Handgriff für 2,4 mm Schaftelektroden mit integriertem Kabel, mit 2 Tasten</p> <p><i>HF-handpiece for 2,4 mm shaft-electr. with integrated cable, two buttons</i></p> <p><i>Pieza manual HF para eje de electr. de 2,4 mm c. cable integrado, c. dos botones</i></p> | 5,0 m | <p>Berchtold / Integra</p>  |
| ST-92244 | <p>HF-Handgriff für 2,4 mm Schaftelektroden mit integriertem Kabel, mit 2 Tasten</p> <p><i>HF-handpiece for 2,4 mm shaft-electrodes with integrated cable, two buttons</i></p> <p><i>Pieza manual HF- para eje de electr. de 2,4 mm c. cable integrado, c. dos botones</i></p> | 5,0 m | <p>Internationale Modelle 3 pol.</p>  <p>modelo internacional 3 patas</p> |







EVO-line HF-Handgriffe mit Kabel, wiederverwendbar, autoklavierbar 134 °C

EVO-line HF-handpiece with integrated cable, reusable, autoclavable 134°C

Línea EVO Pieza manual HF- con cable integrado, reusable, con autoclave en 134° C

| Artikel-Nr. Art. No. Art.N° | Beschreibung Description Descripción | Länge length Largo | Geräteseite Unit connecting Unidad de conexión |
|-----------------------------------|--|--------------------------|--|
|-----------------------------------|--|--------------------------|--|



| | | | |
|----------|--|-------|--|
| ST-92746 | <p>HF-Handgriff für 4 mm Schaftelektroden mit integriertem Kabel, mit 2 Tasten</p> <p><i>HF-handpiece for 4 mm shaft-electrodes with integrated cable, two buttons</i></p> <p><i>Pieza de mano HF para eje de electr. de 4 mm con cable integrado, c. dos botones</i></p> | 3,0 m | <p>Erbe ICC/ACC, Storz</p>  |
| ST-92747 | <p>HF-Handgriff für 4 mm Schaftelektroden mit integriertem Kabel, mit 2 Tasten</p> <p><i>HF-handpiece for 4 mm shaft-electrodes with integrated cable, two buttons</i></p> <p><i>Pieza de mano HF para eje de electr. de 4 mm con cable integrado, c. dos botones</i></p> | 5,0 m | <p>Erbe ICC/ACC, Storz</p>  |
| ST-92741 | <p>HF-Handgriff für 4 mm Schaftelektroden mit integriertem Kabel, mit 2 Tasten</p> <p><i>HF-handpiece for 4 mm shaft-electrodes with integrated cable, two buttons</i></p> <p><i>Pieza de mando HF para eje de electr. de 4 mm c. cable integrado, c. dos botones</i></p> | 3,0 m | <p>Berchtold / Integra</p>  |
| ST-92743 | <p>HF-Handgriff für 4 mm Schaftelektroden mit integriertem Kabel, mit 2 Tasten</p> <p><i>HF-handpiece for 4 mm shaft-electrodes with integrated cable, two buttons</i></p> <p><i>Pieza de mano HF para eje de electr. de 4 mm con cable integrado, c. dos botones</i></p> | 5,0 m | <p>Berchtold / Integra</p>  |
| ST-92740 | <p>HF-Handgriff für 4 mm Schaftelektroden mit integriertem Kabel, mit 2 Tasten</p> <p><i>HF-handpiece for 4 mm shaft-electrodes with integrated cable, two buttons</i></p> <p><i>Pieza de mano HF para eje de electr. de 4 mm c. cable integrado, c. dos botones</i></p> | 3,0 m | <p>Internationale Modelle 3 pol.</p>  <p>modelo internacional 3 patas</p> |
| ST-92745 | <p>HF-Handgriff für 4 mm Schaftelektroden mit integriertem Kabel, mit 2 Tasten</p> <p><i>HF-handpiece for 4 mm shaft-electrodes with integrated cable, two buttons</i></p> <p><i>Pieza de mano HF para eje de electr. de 4 mm con cable integrado, c. dos botones</i></p> | 5,0 m | <p>Internationale Modelle 3 pol.</p>  <p>modelo internacional 3 patas</p> |



HF-Handgriffe mit Kabel, wiederverwendbar, autoklavierbar 134 °C

HF-handpiece with integrated cable, reusable, autoclavable 134°C

Piezas de mano HF con el cable integrado, reusables, con autoclave en 134° C

| Artikel-Nr. Art. No. Art.N° | Beschreibung Description Descripción | Länge length Largo | Geräteseite Unit connecting Unidad de conexión |
|-----------------------------------|--|--------------------------|--|
|-----------------------------------|--|--------------------------|--|



| | | | |
|----------|--|-------|---|
| ST-92644 | <p>HF-Handgriff für 2,4 mm Schaftelektroden mit integriertem Kabel, ohne Tasten</p> <p><i>HF-handpiece for 2,4 mm shaft-electr. with integrated cable, without buttons</i></p> <p><i>Pieza de mano HF para eje de electr. de 2,4 mm con cable integrado sin botones</i></p> | 5,0 m | <p>4 mm Stecker / 4 mm plug / enchufe de 4 mm</p>  |
| ST-92645 | <p>HF-Handgriff für 4 mm Schaftelektroden mit integriertem Kabel, ohne Tasten</p> <p><i>HF-handpiece for 4 mm shaft-electrodes with integrated cable, without buttons</i></p> <p><i>Pieza de mano HF para eje de electr. de 4mm con cable integrado sin botones</i></p> | 5,0 m | <p>4 mm Stecker / 4 mm plug / enchufe 4 mm</p>  |







EVO-line HF-Handgriffe mit integriertem Kabel, wiederverwendbar, autoklavierbar 134 °C

EVO-line HF-handpiece with integrated cable, reusable, autoclavable 134°C

Línea Evo Piezas de mano HF con cable integrado, reusable, con autoclave en 134° C

| Artikel-Nr. Art. No. Art.N° | Beschreibung Description Descripción | Länge length Largo | Geräteseite Unit connecting Unidad de conexión |
|-----------------------------------|--|--------------------------|--|
|-----------------------------------|--|--------------------------|--|







| | | | |
|----------|---|-------|--|
| ST-92750 | <p>HF-Handgriff für 2,4 mm Schaftelektroden mit integriertem Kabel, mit 2 Tasten</p> <p><i>HF-handpiece for 2,4 mm shaft-electrodes with integrated cable, two buttons</i></p> <p><i>Pieza de mano HF para eje de electr. de 2,4 mm c. cable integrado, c. dos botones</i></p> | 3,0 m | <p>Erbe ICC/ACC, Storz</p>  |
| ST-92751 | <p>HF-Handgriff für 2,4 mm Schaftelektroden mit integriertem Kabel, mit 2 Tasten</p> <p><i>HF-handpiece for 2,4 mm shaft-electr. with integrated cable, two buttons</i></p> <p><i>Pieza de mano HF para eje de electr. de 2,4 mm c. cable integrado, c. dos botones</i></p> | 5,0 m | <p>Erbe ICC/ACC, Storz</p>  |
| ST-92749 | <p>HF-Handgriff für 2,4 mm Schaftelektroden mit integriertem Kabel, mit 2 Tasten</p> <p><i>HF-handpiece for 2,4 mm shaft-electrodes with integrated cable, two buttons</i></p> <p><i>Pieza de mano HF para eje de electr. de 2,4 mm c. cable integrado, c. dos botones</i></p> | 3,0 m | <p>Berchtold / Integra</p>  |
| ST-92748 | <p>HF-Handgriff für 2,4 mm Schaftelektroden mit integriertem Kabel, mit 2 Tasten</p> <p><i>HF-handpiece for 2,4 mm shaft-electr. with integrated cable, two buttons</i></p> <p><i>Pieza de mano HF para eje de electr. de 2,4 mm c. cable integrado, c. dos botones</i></p> | 5,0 m | <p>Berchtold / Integra</p>  |
| ST-92742 | <p>HF-Handgriff für 2,4 mm Schaftelektroden mit integriertem Kabel, mit 2 Tasten</p> <p><i>HF-handpiece for 2,4 mm shaft-electr. with integrated cable, two buttons</i></p> <p><i>Pieza de mano HF para eje de electr. de 2,4 mm c. cable integrado, c. dos botones</i></p> | 3,0 m | <p>Internationale Modelle 3 pol.</p>  <p><i>modelo internacional de 3 patas</i></p> |
| ST-92744 | <p>HF-Handgriff für 2,4 mm Schaftelektroden mit integriertem Kabel, mit 2 Tasten</p> <p><i>HF-handpiece for 2,4 mm shaft-electr. with integrated cable, two buttons</i></p> <p><i>Pieza de mano HF para eje de electr. de 2,4 mm c. cable integrado, c. dos botones</i></p> | 5,0 m | <p>Internationale Modelle 3 pol.</p>  <p><i>modelo internacional de 3 patas</i></p> |

HF-Handgriffe, wiederverwendbar, autoklavierbar 134 °C

HF-handpiece, reusable, autoclavable 134°C





















Piezas de mano HF, reusable con autoclave en 134° C

| Artikel-Nr. Art. No. Art. N° | Beschreibung Description Descripción | VPE PU unid. | Geräteseite Unit connecting Unidad de conexión |
|------------------------------------|---|--------------------|---|
| | <p>HF Handgriff für 1,6 mm Schaft - Elektroden mit integriertem Kabel, ohne Tasten</p> <p><i>HF handpiece for 1,6 mm shaft - electr. cable integrated, without buttons</i></p> <p><i>Pieza de mano HF para eje de electr. de 1,6 mm con cable integrado sin botones</i></p> | 1 | <p>Handgriff, dental / plastische Chirurgie</p>  <p><i>Pencil, dental / plastic surgery</i> <i>Lápiz dental para cirugía plástica</i></p> |
| ST-92097 | <p>3 m HF Handgriff - Kabel REGER</p> <p><i>3 m HF handpiece- cable REGER</i></p> <p><i>3m Pieza de mano HF- REGER cable</i></p> | 1 | <p>HF-Gerät / HF-Unit / Unidad HF Martin</p>  |
| ST-92098 | <p>3 m HF Handgriff - Kabel REGER</p> <p><i>3 m HF handpiece - cable REGER</i></p> <p><i>3 m Pieza de mano HF- REGER cable</i></p> | 1 | <p>HF-Gerät / HF-Unit / Unidad HF ERBE</p>  |
| ST-92096 | <p>3 m HF Handgriff - Kabel REGER</p> <p><i>3 m HF handpiece - cable REGER</i></p> <p><i>3m Pieza de mano HF-REGER cable</i></p> | 1 | <p>4 mm Stecker / plug</p>  <p><i>enchufe de 4 mm</i></p> |

HF Kabel, wiederverwendbar, autoclavierbar 134° C

HF Cable, reusable, autoclavable 134° C

HF Cable, reusable, con autoclave en 134° C

| Artikelnr. Art. No. Art.N° | Instrumentenseite Instrument connecting Conexión del instrumento | Länge Length Largo | Geräteseite Unit connecting Unidad de conexión |
|----------------------------------|--|--|--|
| ST-92015 | Pinzettenkabel bipolar (Flachstecker) für: <i>Bipolar forceps cable for:</i> <i>Cable de forceps Bipolares para:</i>  <i>Erbe, Martin, Bowa, Berchtold, Bissinger</i> | 3,0 m |  Erbe ICC/ACC, Storz |
| ST-92016 | | 5,0 m | |
| ST-92017 | | 3,0 m |  Martin, Berchtold |
| ST-92018 | | 5,0 m | |
| ST-92021 | | 3,0 m |  US-Modelle 2 Pol |
| ST-92022 | | 5,0 m | |
| ST-92019 | | 3,0 m |  Internationale Modelle 2 Pol |
| ST-92020 | | 5,0 m | |
| ST-92064 | | 3,0 m |  Internationale Modelle 2 Pol + Instr. Erkennung |
| ST-92023 | Pinzettenkabel bipolar (Flachstecker) für: <i>Bipolar forceps cable for:</i> <i>Cable de forceps Bipolares para:</i>  <i>Erbe, Martin, Bowa, Berchtold, Bissinger</i> | 3,0 m |  Erbe ICC/ACC, Storz |
| ST-92024 | | 5,0 m | |
| ST-92025 | | 3,0 m |  Martin, Berchtold |
| ST-92026 | | 5,0 m | |
| ST-92027 | | 3,0 m |  US-Modelle 2 Pol |
| ST-92028 | | 5,0 m | |
| ST-92029 | | 3,0 m |  Internationale Modelle 2 Pol |
| ST-92030 | | 5,0 m | |
| ST-92110 | | Pinzettenkabel bipolar US-Modelle <i>Bipolar forceps cable US models</i> <i>Cable de forceps Bipolares modelos US</i>  | 3,0 m |
| ST-92111 | 5,0 m | | |
| ST-92113 | 3,0 m | |  Martin, Berchtold |
| ST-92092 | 5,0 m | | |
| ST-92114 | 3,0 m | |  US-Modelle 2 Pol |
| ST-92093 | 5,0 m | | |
| ST-92115 | 3,0 m | |  Internationale Modelle 2 Pol |
| ST-92094 | 5,0 m | | |
| ST-92116 | 3,0 m | |  Wolf |
| ST-92074 | Pinzettenkabel bipolar Aesculap <i>Bipolar forceps cable Aesculap</i> <i>Cable de forceps Bipolares</i>  | 5,0 m |  Erbe ICC/ACC, Storz |
| ST-92073 | | 5,0 m |  Martin, Berchtold |
| ST-92095 | | 5,0 m |  US-Modelle 2 Pol |
| ST-92075 | | 5,0 m |  Internationale Modelle 2 Pol |

HF Kabel, wiederverwendbar, autoclavierbar 134° C

HF Cable, reusable, autoclavable 134° C

















HF Cable, reusable, con autoclave en 134° C

| Artikelnr. Art. No. Art.N° | Instrumentenseite Instrument connecting Conexión del instrumento | Länge Length Largo | Geräteseite Unit connecting Unidad de conexión |
|----------------------------------|---|--------------------------|---|
| ST-92190 | Pinzettenkabel bipolar gewinkelt  | 5,0 m |  Erbe ICC/ACC, Storz |
| ST-92192 |  | 5,0 m |  Martin, Berchtold |
| ST-92194 |  | 5,0 m |  US-Modelle 2 Pol |
| ST-92196 | Bipolar forceps cable angled Cable de forceps bipolar angular | 5,0 m |  Internationale Modelle 2 Pol |

HF Kabel, wiederverwendbar, autoclavierbar 134° C

HF Cable, reusable, autoclavable 134° C



Cable HF, reusable, con autoclave en 134°C

| Artikelnr. Art. No. Art.N° | Instrumentenseite Instrument connecting Conexión del instrumento | Länge Length Largo | Geräteseite Unit connecting Unidad de conexión |
|----------------------------------|--|--------------------------|---|
| ST-92066 | Powerstar Schere Ethicon | 5,0 m |  Erbe ICC/ACC, Storz |
| ST-92068 |  | 5,0 m |  Martin, Berchtold |
| ST-92069 | Powerstar scissors Ethicon | 5,0 m |  US-Modelle 2 Pol |
| ST-92067 | Tijeras Powerstar Ethicon | 5,0 m |  Internationale Modelle 2 Pol |
| ST-92031 |  Storz bipolar | 3,0 m |  Erbe ICC/ACC, Storz |
| ST-92032 | | 5,0 m |  Martin, Berchtold |
| ST-92033 | | 3,0 m | |
| ST-92034 | | 5,0 m | |
| ST-92035 | | 3,0 m |  US-Modelle 2 Pol |
| ST-92036 | | 5,0 m |  Internationale Modelle 2 Pol |
| ST-92037 | | 3,0 m | |
| ST-92038 | | 5,0 m | |
| ST-92009 | Resektoskop Kabel  | 3,0 m | Monopolarkabel 4 mm |
| ST-92010 | Resectoscope cable Cable de resectoscopia | 5,0 m |  monopolar cable 4mm cable monopolar 4 mm |
| ST-92013 | Resektoskop Kabel  | 3,0 m | Big Jack 8 mm |
| ST-92014 | Resectoscope cable Cable de resectoscopia | 5,0 m |  |
| ST-92211 | Resektoskop Kabel Storz gewinkelt | 3,0 m | Martin, Berchtold |
| ST-92212 |  | 5,0 m |  |
| ST-92197 | Resectoscope cable Storz angeled | 3,0m |  internationale Modelle 2 pol. |
| ST-92198 | Cable de resctoscopia angular Storz | 5,0 m | |



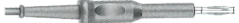

HF Kabel, wiederverwendbar, autoclavierbar 134° C

HF Cable, reusable, autoclavable 134° C

Cable HF, reusable, con autoclave en 134°C

| Artikelnr. Art. No. Art.N° | Instrumentenseite Instrument connecting Conexión del instrumento | Länge Length Largo | Geräteseite Unit connecting Unidad de conexión |
|----------------------------------|--|--------------------------|---|
| ST-92004 | Monopolarkabel 4 mm  | 3,0 m |  |
| ST-92005 | Monopolar cable / cable monopolar 4 mm | 5,0 m | Monopolar cable 4 mm |
| ST-92051 | Monopolarkabel 4 mm  | 3,0 m | Big Jack 8 mm |
| ST-92105 | Monopolar cable / cable monopolar 4 mm | 5,0 m |  |
| ST-92080 | Monopolar 6-kant Arthroskopie  | 3,0 m | Erbe ACC/ICC |
| ST-92081 | Mono. Arthroscopy / Mono.de ArtroscoPía | 5,0 m |  |
| ST-92082 | Monopolar 6-kant Arthroskopie  | 3,0 m | 4 mm Stecker |
| | Mono. Arthroscopy / Mono.de ArtroscoPía | | 4 mm connector / conector |
| ST-92089 | Olympus Buchse  | 3,0 m | 4 mm Stecker |
| ST-92090 | Olympus connector / conector | 5,0 m | 4 mm connector / conector |
| ST-92181 | Monopolar 6-kant Arthroskopie  | 5,0 m | Big Jack 8 mm |
| | Mono. Arthroscopy/Mono. de ArtroscoPía | |  |







HF Gummi-Neutralelektrode, monopolar, wiederverwendbar, autoclavierbar 134° C**HF rubber neutral electrode, monopolar, reusable, autoclavable 134° C****Electrodo neutro de goma HF, reusable, con autoclave en 134°C**

| Artikelnr. Art. No. Art. N° | | Beschreibung description Descripción |
|-----------------------------------|---|--|
| ST-92342 |  | für Erwachsene / <i>for adults / para adultos</i> (260 x 150 mm) Stecker mit zwei Pins / <i>plug with two pins / enchufe de dos patas</i> passend für Kabel mit Art. Nr. / <i>fits cable with ref. ajusta con los cables arts. N°</i> ST-92077, ST-92076, ST-92108, ST-92109 |
| ST-92343 |  | für Kinder / <i>for children / para niños</i> (160 x 180 mm) Stecker mit zwei Pins / <i>plug with two pins con enchufe con dos patas</i> passend für Kabel mit Art. Nr. / <i>fits cable with ref. ajusta con los cables arts N°</i> ST-92077, ST-92076, ST-92108, ST-92109 |
| ST-92308 |  | für Erwachsene / <i>for adults / para adultos</i> (260 x 150 mm) Stecker mit einem Pin / <i>plug with one pin enchufe de una pata</i> passend für Kabel mit Art. Nr. / <i>fits cable with ref. se ajusta a los cables arts. N°</i> ST-92344, ST-92345 |
| ST-92316 |  | für Kinder / <i>for children / para niños</i> (160 x 180 mm) Stecker mit einem Pin / <i>plug with one pin enchufe de una pata</i> passend für Kabel mit Art. Nr. / <i>fits cable with ref. ajusta en los cables arts. N°</i> ST-92344, ST-92345 |





HF Neutralelektrodenkabel, monopolar, wiederverwendbar, autoclavierbar 134° C

HF neutral electrode cable, monopolar, reusable, autoclavable 134° C

Cables de electrodo neutro HF, monopolares, reusables, con autoclave en 134° C

| Artikelnr. Art. No. Art. N° | Instrumentenseite Instrument connecting Conexión del instrumento | Länge Length Largo | Geräteseite Unit connecting Unidad de conexión |
|-----------------------------------|--|--------------------------|--|
| ST-92077 | Neutralelektrode mit <u>Zwei-Pin</u> -Stecker  | 3,0 m | Erbe / Martin / EMED  |
| ST-92076 | Neutral electrode with <u>two-pin</u> -plug Electrodo neutro con enchufe d. <u>dos patas</u> | 5,0 m | |
| ST-92108 | Neutralelektrode mit <u>Zwei-Pin</u> -Stecker  | 3,0 m | Valleylab, Conmed, Bowa  |
| ST-92109 | neutral electrode with <u>two-pin</u> -plug Electrodo neutro con enchufe d. <u>dos patas</u> | 5,0 m | |
| ST-92344 | Neutralelektrode mit <u>Ein-Pin</u> -Stecker  | 3,0 m | Erbe (ICC, ACC) / EMED  |
| ST-92345 | neutral electrode with <u>one-pin</u> -plug Electrodo neutro con enchufe de <u>una pata</u> | 5,0 m | |

HF Neutralelektrodenkabel, monopolar, wiederverwendbar, autoklavierbar 134°C
HF neutral electrode cable, monopolar, reusable, autoclavable 134°C
Cables de electrodos neutros HF, monopolares, reusables, con autoclave en 134°C

| Artikelnr. Art. No. Art. N° | Instrumentenseite Instrument connecting Conexión del instrumento | Länge Length Largo | Geräteseite Unit connecting Unidad de conexión |
|-----------------------------------|--|--------------------------|---|
| ST-92078 | Einweg-Neutralelektrode  | 3,0 m | Erbe / Martin  |
| ST-92039 | single-use neutral electrode electrodo neutro de un solo uso | 5,0 m | |
| ST-92139 | Einweg-Neutralelektrode  single-use neutral electrode electrodo neutro de un solo uso | 5,0 m | Valleylab, Comed, Bowa  |

Bipolare Pinzetten, wiederverwendbar, autoklavierbar 134°C

Bipolar forceps, reusable, autoclavable 134°C

Forceps Bipolares, reusables, con autoclave en 134°C

| Artikelnr. Art. No. Art. N° | Länge (L) length Largo | Spitzenbreite tip width ancho de la punta |
|-----------------------------------|------------------------------|---|
|-----------------------------------|------------------------------|---|

gerade Ausführungen

straight models

modelos rectos



| | | |
|----------|--------|------------------------|
| ST-95019 | 110 mm | Nadel / needle / Aguja |
| ST-95020 | 110 mm | 0,5 mm |
| ST-95022 | 110 mm | 1,0 mm |
| ST-95011 | 160 mm | Nadel / needle / Aguja |
| ST-95170 | 160 mm | 0,5 mm |
| ST-95039 | 160 mm | 1,0 mm |
| ST-95027 | 160 mm | 2,0 mm |
| ST-95181 | 180 mm | Nadel / needle / Aguja |
| ST-95171 | 180 mm | 0,5 mm |
| ST-95180 | 180 mm | 1,0 mm |
| ST-95178 | 180 mm | 2,0 mm |
| ST-95112 | 195 mm | Nadel / needle / Aguja |
| ST-95037 | 195 mm | 0,5 mm |
| ST-95040 | 195 mm | 1,0 mm |
| ST-95029 | 195 mm | 2,0 mm |
| ST-95057 | 195 mm | 2,0 mm Karo |
| ST-95113 | 220 mm | Nadel / needle / Aguja |
| ST-95172 | 220 mm | 0,5 mm |
| ST-95041 | 220 mm | 1,0 mm |
| ST-95030 | 220 mm | 2,0 mm |
| ST-95207 | 260 mm | 2,0 mm |
| ST-95198 | 300 mm | 2,0mm |

Bipolare Pinzetten, wiederverwendbar, autoklavierbar 134°C

Bipolar forceps, reusable, autoclavable 134°C

Forceps bipolares, reusables, con autoclave en 134°C

| Artikelnr. Art. No. Art. N° | Länge (L) length Largo | Spitzenbreite tip width ancho de la punta |
|-----------------------------------|------------------------------|---|
|-----------------------------------|------------------------------|---|

abgewinkelte Ausführungen

angled models

Modelos angulares

Umax: 0,5 KVP



| | | |
|----------|--------|------------------------|
| ST-95023 | 110 mm | Nadel/ needle / Aguja |
| ST-95021 | 110 mm | 0,5 mm |
| ST-95036 | 160 mm | Nadel / needle / Aguja |
| ST-95013 | 160 mm | 0,5 mm |
| ST-95014 | 160 mm | 1,0 mm |
| ST-95187 | 180 mm | Nadel / needle / Aguja |
| ST-95089 | 180 mm | 0,5 mm |
| ST-95090 | 180 mm | 1,0 mm |
| ST-95088 | 180 mm | 2,0 mm |
| ST-95103 | 195 mm | Nadel / needle / Aguja |
| ST-95104 | 195 mm | 0,5 mm |
| ST-95001 | 195 mm | 1,0 mm |
| ST-95007 | 195 mm | 2,0 mm |
| ST-95058 | 195 mm | 2,0 mm Karo |
| ST-95126 | 220 mm | Nadel / needle / Aguja |
| ST-95122 | 220 mm | 0,5 mm |
| ST-95024 | 220 mm | 1,0 mm |
| ST-95125 | 220 mm | 2,0 mm |
| ST-95207 | 260 mm | 2,0 mm |

Bipolare Pinzetten, wiederverwendbar, autoklavierbar 134°C

Bipolar forceps, reusable, autoclavable 134°C

Forceps Bipolares, reusables, con autoclave en 134°C

| Artikelnr. Art. No. Art. N° | Länge (L) length Largo | Spitzenbreite tip width ancho de la punta |
|-----------------------------------|------------------------------|---|
|-----------------------------------|------------------------------|---|

bajonett Ausführungen

bayonet models

Modelos Bayoneta

Umax: 0,5 KVP



| | | |
|----------|--------|------------------------|
| ST-95116 | 165 mm | Nadel / needle / Aguja |
| ST-95017 | 165 mm | 0,5 mm |
| ST-95018 | 165 mm | 1,0 mm |
| ST-95194 | 180 mm | Nadel / needle / Aguja |
| ST-95092 | 180 mm | 0,5 mm |
| ST-95091 | 180 mm | 1,0 mm |
| ST-95093 | 180 mm | 2,0 mm |
| ST-95008 | 195 mm | Nadel / needle / Aguja |
| ST-95109 | 195 mm | 0,5 mm |
| ST-95002 | 195 mm | 1,0 mm |
| ST-95034 | 195 mm | 2,0 mm |
| ST-95059 | 195 mm | 2,0 mm Karo |
| ST-95045 | 220 mm | Nadel / needle / Aguja |
| ST-95031 | 220 mm | 0,5 mm |
| ST-95131 | 220 mm | 1,0 mm |
| ST-95132 | 220 mm | 2,0 mm |
| ST-95197 | 240 mm | 0,5 mm |
| ST-95196 | 240 mm | 1,0 mm |

Bipolare Pinzetten, wiederverwendbar, autoklavierbar 134°C

Bipolar forceps, reusable, autoclavable 134°C

Forceps Bipolares, reusables, con autoclave en 134°C

| Artikelnr. Art. No. Art. N° | Länge (L) length Largo | Spitzenbreite tip width ancho de la punta |
|-----------------------------------|------------------------------|---|
|-----------------------------------|------------------------------|---|

bajonett Ausführungen, aufwärts gewinkelt

bayonet models, angled up

Modelos Bayoneta, angulares hacia arriba

Umax: 0,5 KVP



| | | |
|----------|--------|--------|
| ST-95026 | 195 mm | 1,0 mm |
|----------|--------|--------|

| | | |
|----------|--------|--------|
| ST-95063 | 220 mm | 1,0 mm |
|----------|--------|--------|

bajonett Ausführungen, abwärts gewinkelt

bayonet models, angled down

Modelos Bayoneta, angulares hacia abajo

Umax: 0,5 KVP



| | | |
|----------|--------|--------|
| ST-95065 | 195 mm | 1,0 mm |
|----------|--------|--------|

| | | |
|----------|--------|--------|
| ST-95067 | 220 mm | 1,0 mm |
|----------|--------|--------|

Bipolare Pinzetten Antihaft "New Generation", wiederverwendbar, autoklavierbar 134°C

Bipolar forceps non-stick "New Generation", reusable, autoclavable 134°C

Forceps bipolares antiadherentes "Nueva Generación", reusables, con autoclave en 134°C

| Artikelnr. Art. No. Art. N° | Länge (L) length Largo | Spitzenbreite tip width ancho de la punta |
|-----------------------------------|------------------------------|---|
|-----------------------------------|------------------------------|---|

gerade Ausführungen

straight models

modelos rectos

Umax: 0,5 KVp



| | | |
|--------------|--------|------------------------|
| ST-95019 ANG | 110 mm | Nadel/ needle / Aguja |
| ST-95020 ANG | 110 mm | 0,5 mm |
| ST-95011 ANG | 160 mm | Nadel |
| ST-95170 ANG | 160 mm | 0,5 mm |
| ST-95039 ANG | 160 mm | 1,0 mm |
| ST-95027 ANG | 160 mm | 2,0 mm |
| ST-95181 ANG | 180 mm | Nadel / needle / Aguja |
| ST-95171 ANG | 180 mm | 0,5 mm |
| ST-95180 ANG | 180 mm | 1,0 mm |
| ST-95178 ANG | 180 mm | 2,0 mm |
| ST-95112 ANG | 195 mm | Nadel / needle / Aguja |
| ST-95037 ANG | 195 mm | 0,5 mm |
| ST-95040 ANG | 195 mm | 1,0 mm |
| ST-95029 ANG | 195 mm | 2,0 mm |
| ST-95057 ANG | 195 mm | 2,0 mm Karo |
| ST-95113 ANG | 220 mm | Nadel / needle / Aguja |
| ST-95172 ANG | 220 mm | 0,5 mm |
| ST-95041 ANG | 220 mm | 1,0 mm |
| ST-95030 ANG | 220 mm | 2,0 mm |
| ST-95207 ANG | 260 mm | 2,0 mm |
| ST-95198 ANG | 300 mm | 2,0mm |

Bipolare Pinzetten Antihaft "New Generation", wiederverwendbar, autoklavierbar 134°C

Bipolar forceps non-stick "New Generation", reusable, autoclavable 134°C

Forceps Bipolares antiadherentes "Nueva Generación", reusables, con autoclave en 134°C

| Artikelnr. Art. No. Art. N° | Länge (L) length Largo | Spitzenbreite tip width ancho de la punta |
|-----------------------------------|------------------------------|---|
|-----------------------------------|------------------------------|---|

abgewinkelte Ausführungen

Umax: 0,5 KVP

angled models

modelos angulares

keine Abbildung vorhanden / no image available / imágenes no disponible

| | | |
|--------------|--------|------------------------|
| ST-95023 ANG | 110 mm | Nadel / needle / Aguja |
| ST-95021 ANG | 110 mm | 0,5 mm |
| ST-95036 ANG | 160 mm | Nadel / needle / Aguja |
| ST-95013 ANG | 160 mm | 0,5 mm |
| ST-95014 ANG | 160 mm | 1,0 mm |
| ST-95187 ANG | 180 mm | Nadel / needle / Aguja |
| ST-95089 ANG | 180 mm | 0,5 mm |
| ST-95090 ANG | 180 mm | 1,0 mm |
| ST-95088 ANG | 180 mm | 2,0 mm |
| ST-95103 ANG | 195 mm | Nadel / needle / Aguja |
| ST-95104 ANG | 195 mm | 0,5 mm |
| ST-95001 ANG | 195 mm | 1,0 mm |
| ST-95007 ANG | 195 mm | 2,0 mm |
| ST-95058 ANG | 195 mm | 2,0 mm Karo |
| ST-95126 ANG | 220 mm | Nadel / needle / Aguja |
| ST-95122 ANG | 220 mm | 0,5 mm |
| ST-95024 ANG | 220 mm | 1,0 mm |
| ST-95125 ANG | 220 mm | 2,0 mm |
| ST-95207 ANG | 260 mm | 2,0 mm |

Bipolare Pinzetten Antihaft "New Generation", wiederverwendbar, autoklavierbar 134°C

Bipolar forceps non-stick "New Generation", reusable, autoclavable 134°C

Forceps bipolares antiadherentes "Nueva Generación", reusables, con autoclave en 134°C

| Artikelnr. Art. No. Art. N° | Länge (L) length Largo | Spitzenbreite tip width ancho de la punta |
|-----------------------------------|------------------------------|---|
|-----------------------------------|------------------------------|---|

bajonett Ausführungen

Umax: 0,5 KVP

bayonet models

Modelos Bayoneta



| | | |
|--------------|--------|------------------------|
| ST-95116 ANG | 165 mm | Nadel / needle / Aguja |
| ST-95017 ANG | 165 mm | 0,5 mm |
| ST-95018 ANG | 165 mm | 1,0 mm |
| ST-95194 ANG | 180 mm | Nadel / needle / Aguja |
| ST-95092 ANG | 180 mm | 0,5 mm |
| ST-95091 ANG | 180 mm | 1,0 mm |
| ST-95093 ANG | 180 mm | 2,0 mm |
| ST-95008 ANG | 195 mm | Nadel / needle / Aguja |
| ST-95109 ANG | 195 mm | 0,5 mm |
| ST-95002 ANG | 195 mm | 1,0 mm |
| ST-95034 ANG | 195 mm | 2,0 mm |
| ST-95059 ANG | 195 mm | 2,0 mm Karo |
| ST-95045 ANG | 220 mm | Nadel / needle / Aguja |
| ST-95031 ANG | 220 mm | 0,5 mm |
| ST-95131 ANG | 220 mm | 1,0 mm |
| ST-95132 ANG | 220 mm | 2,0 mm |
| ST-95197 ANG | 240 mm | 0,5 mm |
| ST-95196 ANG | 240 mm | 1,0 mm |

Bipolare Pinzetten Antihaft "New Generation", wiederverwendbar, autoklavierbar 134°C

Bipolar forceps non-stick "New Generation", reusable, autoclavable 134°C

Forceps Bipolares antiadherentes "Nueva Generación", reusables, con autoclave en 134°C

| Artikelnr. Art. No. Art. N° | Länge (L) length Largo | Spitzenbreite tip width ancho de la punta |
|-----------------------------------|------------------------------|---|
|-----------------------------------|------------------------------|---|

Umax: 0,5 KVp

bajonett Ausführungen, aufwärts gewinkelt

bayonet models, angled up

Modelos Bayoneta, angulares hacia arriba

keine Abbildung vorhanden / *no image available / imágenes no disponible*

| | | |
|--------------|--------|--------|
| ST-95026 ANG | 195 mm | 1,0 mm |
| ST-95063 ANG | 220 mm | 1,0 mm |

Umax: 0,5 KVp

bajonett Ausführungen, abwärts gewinkelt

bayonet models, angled down

Modelos Bayoneta, angulares hacia arriba

keine Abbildung vorhanden / *no image available / imágenes no disponible*

| | | |
|--------------|--------|--------|
| ST-95065 ANG | 195 mm | 1,0 mm |
| ST-95067 ANG | 220 mm | 1,0 mm |